

# Environmental benefits of recycling

## Appendix 6 – Plastics

PET, HDPE, PVC, mixed plastics  
and rubber tyres



**Disclaimer**

The Department of Environment, Climate Change and Water NSW has made all reasonable efforts to ensure that the contents of this document are free from factual error. However, the DECCW shall not be liable for any damage or loss, which may occur in relation to any person taking action or not on the basis of this document.

**Published by**

Department of Environment, Climate Change and Water NSW  
59–61 Goulburn Street  
PO Box A290  
Sydney South 1232  
Ph: (02) 9995 5000 (switchboard)  
Ph: 131 555 (environment information and publications requests)  
Ph: 1300 361 967 (national parks information and publications requests)  
Fax: (02) 9995 5999  
TTY: (02) 9211 4723  
Email: [info@environment.nsw.gov.au](mailto:info@environment.nsw.gov.au)  
Website: [www.environment.nsw.gov.au](http://www.environment.nsw.gov.au)

DECCW 2010/58

ISBN 978 1 74232 530 9

June 2010

© Copyright Department of Environment, Climate Change and Water NSW June 2010

The Department of Environment, Climate Change and Water NSW is pleased to allow this material to be reproduced in whole or in part, provided the meaning is unchanged and its source, publisher and authorship are acknowledged.

# Table of Contents

Understanding network diagrams .....	5
<b>PET</b> .....	<b>6</b>
<b>Process description</b> .....	<b>6</b>
A) Kerbside collection system.....	7
Processes considered.....	7
Results.....	8
Key assumptions .....	8
Data Quality table and comment .....	10
B) C&I and C&D collection system .....	10
Processes considered.....	10
Results.....	10
Key assumptions .....	11
Data Quality table and comment .....	12
<b>References</b> .....	<b>13</b>
Network diagrams — Kerbside collection .....	14
<b>HDPE</b> .....	<b>22</b>
<b>Process Description</b> .....	<b>22</b>
A) Kerbside collection system.....	23
Processes considered.....	23
Results.....	24
Key assumptions .....	24
Data Quality table and comment .....	25
B) C&I and C&D collection system .....	26
Processes considered.....	26
Results.....	26
Key assumptions .....	27
Data quality table and comment.....	28
<b>References</b> .....	<b>29</b>
Network diagrams — Kerbside collection .....	30
Network diagrams — C&I and C&D collection.....	34
<b>PVC</b> .....	<b>38</b>
<b>Process description</b> .....	<b>38</b>
A) Kerbside collection system .....	39
Processes considered.....	39
Results.....	40
Key assumptions .....	40
Data Quality .....	41
B) C&I and C&D collection system .....	42
Processes considered.....	42
Results.....	42
Key assumptions .....	42
Data Quality .....	43
<b>References</b> .....	<b>44</b>
Network diagrams — Kerbside collection .....	45
Network diagrams — C&I and C&D collection.....	49
<b>Mixed plastics</b> .....	<b>53</b>

<b>Process description</b> .....	<b>53</b>
A) Kerbside collection system.....	54
Processes considered.....	54
Results.....	55
Key assumptions .....	55
Data quality table and comment.....	57
B) C&I and C&D collection system .....	57
Processes considered.....	57
Results.....	57
Key assumptions .....	58
Data quality table and comment.....	59
<b>References</b> .....	<b>59</b>
Network diagrams — Kerbside collection.....	61
Network diagrams — C&I and C&D collection.....	65
<b>Rubber tyres</b> .....	<b>69</b>
<b>Process Description</b> .....	<b>69</b>
Results.....	70
Key assumptions .....	70
Data Quality.....	71
<b>References</b> .....	<b>72</b>
Network diagrams — C&I and C&D collection.....	73

## List of tables and figures

Figure 1: Sample network diagram. ....	5
Figure 2: Processes considered in determining the net impacts of the recycling process from kerbside and C&I and C&D sources.....	7
Table 1: Benefits and impacts of recycling of PET from kerbside sources (per tonne) .....	8
Table 2: Inventory for recycling 1 tonne of PET, from kerbside source .....	8
Table 3: Data quality for life cycle inventory data modelled for recycling and landfilling of PET from kerbside source (1 tonne) .....	10
Table 4: Benefits and impacts of recycling PET from C&I and C&D sources (per tonne) .....	11
Table 5: Inventory for recycling 1 tonne of PET from C&I and C&D source .....	11
Table 6: Data quality for life cycle inventory data modelled for recycling and landfilling of PET from C&I and C&D source (1 tonne).....	12
Figure 3: Recycling process network diagram — Green house gases indicator .....	14
Figure 4: Recycling process network diagram — Cumulative energy demand indicator .....	15
Figure 5: Recycling process network diagram — Water indicator .....	16
Figure 6: Recycling process network diagram — Solid waste indicator.....	17
Figure 7: Recycling process network diagram — Green house gases indicator .....	18
Figure 8: Recycling process network diagram — Cumulative energy demand indicator.....	19
Figure 9: Recycling process network diagram — Water indicator .....	20
Figure 10: Recycling process network diagram — Solid waste indicator.....	21
Figure 11: Processes considered in determining the net impacts of the recycling process from kerbside and C&I and C&D sources.....	23
Table 7: Benefits and impacts of recycling HDPE from a kerbside source (per tonne).....	24
Table 8: Inventory for recycling 1 tonne of HDPE from a kerbside source .....	24

Table 9:	Data quality for life cycle inventory data modelled for recycling and landfilling of HDPE, kerbside source (1 tonne).....	26
Table 10:	Benefits and impacts of recycling HDPE from C&I and C&D sources (per tonne) .....	27
Table 11:	Inventory for recycling 1 tonne of HDPE from C&I and C&D source.....	27
Table 12:	Data quality for life cycle inventory data modelled for recycling and landfilling of HDPE from C&I and C&D source (1 tonne).....	28
Figure 12:	Recycling process network diagram — Green house gases indicator .....	30
Figure 13:	Recycling process network diagram — Cumulative energy demand indicator.....	31
Figure 14:	Recycling process network diagram — Water indicator .....	32
Figure 15:	Recycling process network diagram — Solid waste indicator.....	33
Figure 16:	Recycling process network diagram — Green house gases indicator .....	34
Figure 17:	Recycling process network diagram — Cumulative energy demand indicator.....	35
Figure 18:	Recycling process network diagram — Water indicator .....	36
Figure 19:	Recycling process network diagram — Solid waste indicator.....	37
Figure 20:	Processes considered in determining the net impacts of the recycling process from kerbside and C&I and C&D sources.....	39
Table 13:	Benefits and impacts of recycling PVC from a kerbside source (per tonne) .....	40
Table 14:	Inventory for recycling of PVC, kerbside source (1 tonne).....	40
Table 15:	Data quality for life cycle inventory data modelled for recycling and landfilling of PVC, kerbside source (1 tonne) .....	41
Table 16:	Benefits and impacts of recycling PVC from C&I and C&D sources (per tonne).....	42
Table 17:	Inventory for recycling of PVC, C&I, C&D sources (1 tonne) .....	43
Table 18:	Data quality for life cycle inventory data modelled for recycling and landfilling of PVC, kerbside source (1 tonne) .....	43
Figure 21:	Recycling process network diagram — Green house gases indicator .....	45
Figure 22:	Recycling process network diagram — Cumulative energy demand indicator.....	46
Figure 23:	Recycling process network diagram — Water indicator .....	47
Figure 24:	Recycling process network diagram — Solid waste indicator.....	48
Figure 25:	Recycling process network diagram — Green house gases indicator .....	49
Figure 26:	Recycling process network diagram — Cumulative energy demand indicator.....	50
Figure 27:	Recycling process network diagram — Water indicator .....	51
Figure 28:	Recycling process network diagram — Solid waste indicator.....	52
Figure 29:	Processes considered in determining the net impacts of the recycling process from kerbside and C&I and C&D sources.....	54
Table 19:	Benefits and impacts of recycling mixed plastics from kerbside sources (per tonne) .....	55
Table 20:	Inventory for recycling mixed plastics (1 tonne).....	56
Table 21:	Data quality for life cycle inventory data modelled for recycling and landfilling of mixed plastics, kerbside source .....	57
Table 22:	Benefits and impacts of recycling mixed plastics from C&I and C&D sources (per tonne) .....	58
Table 23:	Inventory for recycling mixed plastics (1 tonne).....	58
Table 24:	Data quality for life cycle inventory data modelled for recycling and landfilling of mixed plastics .....	59
Figure 30:	Recycling process network diagram — Green house gases indicator .....	61
Figure 31:	Recycling process network diagram — Cumulative energy demand indicator.....	62

Figure 32: Recycling process network diagram — Water indicator .....	63
Figure 33: Recycling process network diagram — Solid waste indicator .....	64
Figure 34: Recycling process network diagram — Green house gases indicator .....	65
Figure 35: Recycling process network diagram — Cumulative energy demand indicator.....	66
Figure 36: Recycling process network diagram — Water indicator .....	67
Figure 37: Recycling process network diagram — Solid waste indicator.....	68
Figure 38: Processes considered in determining the net impacts of the recycling process from C&I and C&D sources.....	70
Table 25: Benefits and impacts of recycling and avoided landfill of waste tyres from C&I and C&D source (per tonne) .....	70
Table 26: Inventory for recycling waste tyres from C&I and C&D source (1 tonne) .....	71
Table 27: Data quality for life cycle inventory data modelled for recycling and landfilling of waste tyres from C&I and C&D source.....	72
Figure 39: Recycling process network diagram — Green house gases indicator .....	73
Figure 40: Recycling process network diagram — Cumulative energy demand indicator.....	74
Figure 41: Recycling process network diagram — Water indicator .....	75
Figure 42: Recycling process network diagram — Solid waste indicator.....	76

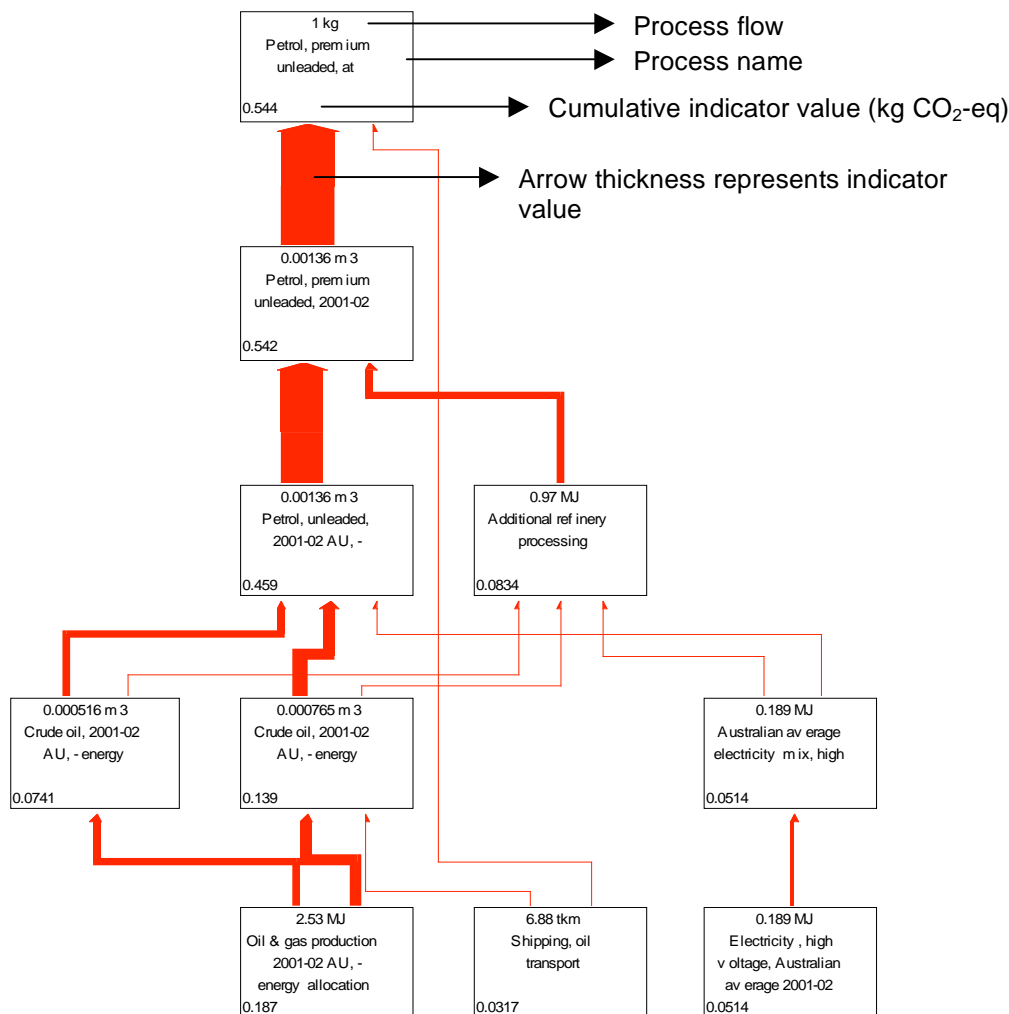
## Understanding network diagrams

This appendix presents the data sources and assumptions used in modelling the life cycle stages. Most of the data is contained and modelled in LCA software and consists of hundreds of individual unit process processes. To help provide transparency on the inventories used for the background processes, process network diagrams are presented.

To interpret the process network, start at the top of the tree representing the functional output of the process (e.g. petrol premium unleaded, shown in Figure 1). The amount and unit of the process is shown in the upper number in the unit process box (1kg). The lower number (in the bottom left hand corner) represents an indicator value which, in this case, is set to show cumulative greenhouse gas contributions in kilograms of equivalent carbon dioxide (CO<sub>2</sub> eq). The arrow thickness represents the indicator value (the thicker the arrow the more impact that process is contributing). Note that minor processes may not be physically shown in the process network if the indicator value falls below a specific cut-off level, though their contribution to the overall functional unit (the top box in the diagram) is still included. The network diagram may also be truncated at the bottom to improve readability of the networks. Finally, some diagrams may not show the process flows for confidentiality reasons.

Some network diagrams will include green process flow arrows. These arrows represent beneficial flows (negative impacts) and are common when viewing recycling processes. In recycling processes, negative cumulative indicator values (lower left hand corner) will typically be associated with avoided processes, such as avoided primary material production and avoided landfill.

**Figure 1: Sample network diagram.**



# PET

## *Process description*

Polyethylene terephthalate (PET) is a thermoplastic polymer resin of the polyester family, commonly used as a raw material for the production of packaging. The reprocessing involves shredding of the PET into flakes, followed by the extraction of all contaminants (metal, paper and other plastic materials). The pure PET flakes can then be used as a substitute for virgin PET. The replacement ratio is one to one, after taking into account the losses during sorting and cleaning of used PET.

### **Two collection systems for PET waste were considered in the model:**

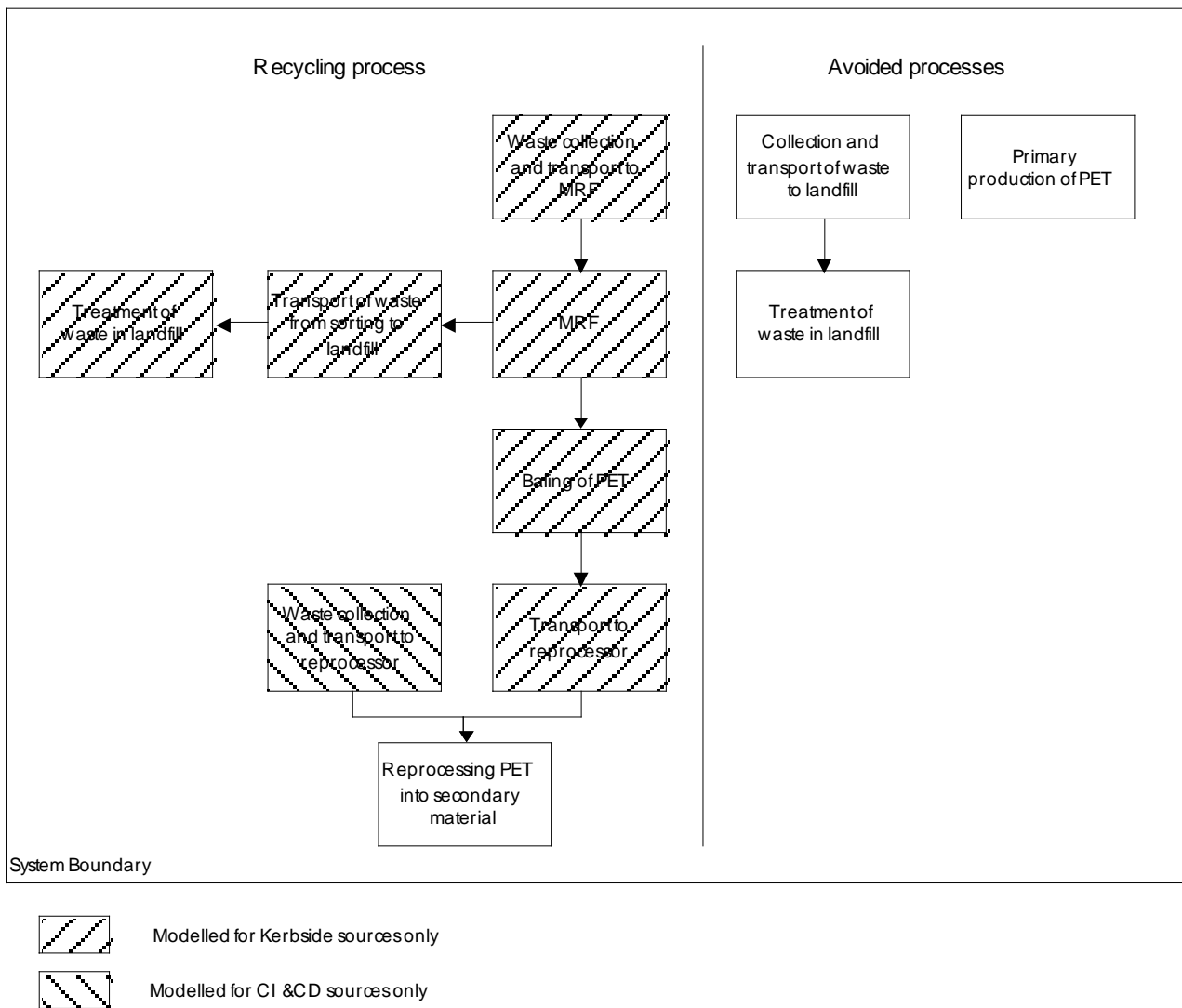
- A) Kerbside collection — municipal collection of PET in commingled from households, and processing through a Materials Recovery Facility.
- B) C&I, C&D collection — the segregated waste collected is sent directly to the reprocessing site without any sorting process, or associated losses.

The unique nature of each collection system drives differences in the impacts associated with PET recycling. For this reason the PET recycling processes considered and impacts generated have been described separately in the following sections, according to the collection method used.

Figure 2 illustrates the processes considered in determining the overall impact of PET recycling from kerbside and C&I and C&D sources (shown to the left of the vertical line), and the processes considered in determining the overall impact of the avoided processes (shown to the right of the vertical line).



**Figure 2: Processes considered in determining the net impacts of the recycling process from kerbside and C&I and C&D sources.**



## A) Kerbside collection system

### *Processes considered*

The kerbside collection system involves collection of waste for recycling from the kerbside and transport to a Materials Recovery Facility (MRF) which sorts the commingled materials in the recycling stream. The model developed takes into account transportation impacts as well as sorting impacts incurred to bring the material from the kerbside to the material reprocessing facility. During sorting, waste material is generated and transported to landfill.

Once at the reprocessing facility, the model considers the impacts of material reprocessing required to convert the waste material back into usable PET. Losses associated with this process are included in the analysis. The kerbside treatment system is illustrated in Figure 2 (processes unique to kerbside collection shaded accordingly).

In order to determine the net benefit of recycling a material, it is also necessary to consider the processes avoided when recycling is undertaken. Figure 2 also illustrates the processes that would be avoided if waste PET were to be recycled (shown to the right of the vertical line). Two main avoided processes are considered; the collection and disposal to landfill of waste PET from the kerbside, and the primary manufacture of PET from virgin resources.

## Results

Considering both the recycling process flows and the avoided process flows, described in Figure 2, an inventory of environmental flows was developed. This inventory was then assessed using the Australian Impact Assessment Method, with results described in Table 1.

**Table 1: Benefits and impacts of recycling of PET from kerbside sources (per tonne). Benefits are shown negative, impacts are shown positive.**

Impact category	Unit	Recycling process impacts (Figure 104 - left side)	Avoided process impacts (Figure 104 - right side)			Net benefits of recycling
		Collection, sorting and reprocessing	Collection and landfill	Primary material production	Total avoided impacts	
Green house gases	t CO <sub>2</sub>	1.59	-0.24	-2.30	-2.54	-0.95
Cumulative energy demand	GJ LHV	20.47	-3.38	-65.53	-68.91	-48.45
Water use	kL H <sub>2</sub> O	29.65	-0.03	-9.24	-9.27	20.38
Solid waste	tonnes	0.19	-0.95	-0.02	-0.97	-0.78

Network diagrams detailing key processes that influence the impacts listed in Table 1 are shown in Figure 3 to Figure 6. For further information regarding interpretation of network diagrams, refer to Understanding Network Diagrams (Figure 1).

## Key assumptions

Table 2 describes the key processes and data sources used to determine the benefits and impacts associated with the collection, recycling and reprocessing of 1 tonne of PET from kerbside source. The table also includes the products and processes avoided when 1 tonne of PET is recycled.

**Table 2: Inventory for recycling 1 tonne of PET, from kerbside source**

Item	Flow	Unit	Comment
<b>Recycling process flows (Figure 2 — left hand side)</b>			
Waste collection and transport to MRF	23.7	m <sup>3</sup>	Based on PET bulk density of 21.6 m <sup>3</sup> /tonne plus 10 per cent for other material collected with it but disposed at MRF, Grant (2001a) Transport model for kerbside collection based on Grant (2001b); refer appendices for discussion on transport. Emission of the truck from NGGIC (1997)
Sorting of PET at Material Recovery Facility (MRF)	23.7	m <sup>3</sup>	Based on PET bulk density of 21.6 m <sup>3</sup> /tonne plus 2.16 m <sup>3</sup> for carrying 10% non recyclables as contamination in collection from Grant (2001a) Energy inputs from Nishtala (1997) and estimated from equipment specifications
Baling of PET	0.9	tonne	Estimated loss of 10 per cent at MRF from Grant (2001b) Electricity inputs from Nishtala (1997), 12kWh per tonne.
Transport to reprocessor	800	km	35 per cent of HDPE waste sent to Visy Recycling (Melbourne) 800km, from Grant (2001b); articulated truck, 7 tonne load on 30 tonne truck, 90 per cent rural operation Data from urban operation: fuel use data are from Apelbaum (1997). Greenhouse related emissions are based on fuel use with factors taken from NGGIC (1997). Non greenhouse emissions apart from lead are taken from Delft (1996). Data from rural operation: data generated from NGGIC (2004), and Ecolnvent for toxic emissions

Item	Flow	Unit	Comment
<b>Recycling process flows (Figure 2 — left hand side)</b>			
Transport to reprocessor	65	km	50 per cent sent to Coca-Cola (Sydney), 65km assumption (Grant 2001b); Articulated truck, 7 tonne load on 30 tonne truck Fuel use data are from Apelbaum (1997). Greenhouse related emissions are based on fuel use with factors taken from NGGIC (1997). Non greenhouse emissions apart from lead are taken from Delft (1996).
Transport to reprocessor	9000	km	15 per cent export to China (Grant, 2001b), 9000km; shipping, international freight Fuel use data are from Apelbaum (1997). Greenhouse related emissions are based on fuel use with factors taken from NGGIC (1997). Non greenhouse emissions apart from lead are taken from Delft (1996).
Reprocessing PET into secondary material	0.9	tonne	10 per cent assumed lost at reprocessing, so process ends up with 0.81 tonne reprocessed PET output. Assumption that reprocessing is similar in the three locations. Input and emissions are an aggregated data from Idemat (1996), Buwal250 and personal communication with Visy staff.
Transport of waste from sorting to landfill	20	km	Emissions from transport based on an articulated truck, 28 tonne load on 30 tonne truck. Trucking model developed from data provided by Apelbaum (2001)
Treatment of waste in landfill	0.1	tonne	Material discarded at MRF treated in landfill. Emission factors for total plastics from Tellus (1992). Operation to the landfill from a personal communication with S. Middleton, Pacific Waste, NSW, 1998
<b>Avoided process flows (Figure 2 — right hand side)</b>			
Collection and transport of waste to landfill	27.3	m <sup>3</sup>	Waste collection avoided by sending material to MRF above. Transport model for kerbside collection based on Grant (2001b); refer appendices for discussion on transport. Emission of the truck from Apelbaum (2001), NGGIC (1997) and other sources.
Treatment of waste in landfill	1	tonne	Emission factors for total plastics from Tellus (1992). Operation to the landfill from a personal communication with S. Middleton, Pacific Waste, NSW, 1998
Primary production of PET	0.81	tonne	Reprocessing ends up with 0.81 tonne of reprocessed PET thereby avoiding 0.81 tonne of virgin PET production. Data from Ecolnvent adapted to Australian context (energy, transport, materials).

### *Data Quality table and comment*

Table 3 presents a summary of the data quality for the main processes considered. It shows the data sources used; if they are general data or specific to a company; the age of the data; the geographic location that the data were based on; and, the nature of the technology considered.

**Table 3: Data quality for life cycle inventory data modelled for recycling and landfilling of PET from kerbside source (1 tonne)**

	<b>Primary data source</b>	<b>Geography</b>	<b>Data Age</b>	<b>Technology</b>	<b>Representativeness</b>
Impact of transport	Ecolinvent, NGGI, Apelbaum (1997) and Delft (1996) and other sources	European data adapted to Australian conditions and Australian data	2005	Average technology	Mixed data
Reprocessing PET	Aggregated data: Idemat Buwal250 and Visy	Australia	2004	Unspecified	Unspecified
Avoided PET production	Adapted from Ecolinvent	European data adapted to Australian conditions	2005	Unspecified	Unspecified
Avoided landfill impacts	Tellus Institute	Australia	1999	Unspecified	Mixed Data

## **B) C&I and C&D collection system**

### *Processes considered*

In the case of the C&I and C&D collection system, it has been assumed that segregated waste collected is sent directly to the reprocessing site without any sorting process, or associated losses. The model developed takes into account transportation impacts incurred to bring the material from C&I and C&D sources to the material reprocessing facility.

Once at the reprocessing facility, the model considers the impacts of material reprocessing required to convert the waste material into secondary PET. Losses associated with this process are included in the analysis. The model also illustrates the processes considered in determining the impact of the processes avoided when recycling PET from C&I and C&D sources. Three main processes are considered, the collection of PET waste and landfill treatment, and the primary manufacture of PET from virgin resources. The system is also described in Figure2 (processes unique to C&I,C&D collection are shaded accordingly).

### *Results*

Considering both the recycling process flows and the avoided process flows, described in Figure 2, an inventory of environmental flows was developed. This inventory was then assessed using the Australian Impact Assessment Method, with results described in Table 4.

**Table 4: Benefits and impacts of recycling PET from C&I and C&D sources (per tonne)**

Impact category	Unit	<u>Recycling process impacts</u> (Figure 104 - left side)	<u>Avoided process impacts</u> (Figure 104 - right side)			<u>Net benefits of recycling</u>
		Collection, sorting and reprocessing	Collection and landfill	Primary material production	Total avoided impacts	
Green house gases	t CO <sub>2</sub>	1.38	-0.01	-2.56	-2.57	-1.18
Cumulative energy demand	GJ LHV	17.46	-0.13	-72.81	-72.94	-55.49
Water use	kL H <sub>2</sub> O	32.83	0.00	-10.27	-10.27	22.56
Solid waste	tonnes	0.20	-0.95	-0.02	-0.97	-0.77

Network diagrams detailing key processes that influence the impact listed in Table 4 are shown in Figure 7 to Figure 10. For further information regarding interpretation of network diagrams, refer to Understanding Network Diagrams (Figure 1).

### Key assumptions

Table 5 describes the key processes and data sources used to determine the benefits and impacts associated with the collection, recycling and reprocessing of 1 tonne of PET. The table also includes the products and processes avoided when 1 tonne of PET is recycled.

**Table 5: Inventory for recycling 1 tonne of PET from C&I and C&D source**

Item	Flow	Unit	Comment
<b>Recycling process flows (Figure 2 — left hand side)</b>			
Collection of material for recycling	20	km	20km distance estimate based on a simplified transport analysis for Sydney; refer appendices for discussion on transport. Emissions from transport based on a trucking model developed by the Centre for Design, incorporating trucking data from Apelbaum (2001) and other sources. Truck backhaul ratio assumed to be 1:2.
Transport to reprocessing	9000	km	15% export to China (Grant, 2001), 9000km; shipping, international freight Fuel use data are from Apelbaum (1997). Greenhouse related emissions are based on fuel use with factors taken from NGGIC (1997). Non greenhouse emissions apart from lead are taken from Delft (1996).
Transport to reprocessing	65	km	50 per cent sent to Coca-Cola (Sydney), 65km assumption (Grant 2001b) Fuel use data are from Apelbaum (1997). Greenhouse related emissions are based on fuel use with factors taken from NGGIC (1997). Non greenhouse emissions apart from lead are taken from Delft (1996).
Transport to reprocessing	800	km	35 per cent of HDPE waste sent to Visy Recycling (Melbourne) 800km, from Grant (2001b) Data from urban operation: fuel use data are from Apelbaum (1997). Greenhouse related emissions are based on fuel use with factors taken from NGGIC (1997). Non greenhouse emissions apart from lead are taken from Delft (1996). Data from rural operation: data generated from NGGIC (2004), and EcoInvent for toxic emissions

Item	Flow	Unit	Comment
PET reprocessing	1	tonne	10 per cent assumed lost at reprocessing, so process ends up with 0.9 tonne reprocessed PET output. Assumption that reprocessing is similar in the three locations. Input and emissions are an aggregated data from Idemat (1996), Buwal250 and personal communication with Visy staff.
Transport of waste from sorting to landfill	20	km	Emissions from transport based on an articulated truck, 28 tonne load on 30 tonne truck. Trucking model developed from data provided by Apelbaum (2001)
Treatment of waste in landfill	0.1	tonne	Assumed reject rate from reprocessing. Emission factors for total plastics from Tellus (1992). Operation to the landfill from a personal communication with S. Middleton, Pacific Waste, NSW, 1998
<b>Avoided process flows (Figure 2 — right hand side)</b>			
Collection and transport of waste to landfill	20	km	Emissions from transport based on an articulated truck, 28 tonne load on 30 tonne truck. Trucking model developed from data provided by Apelbaum (2001). Refer appendices for transport discussion.
Landfill of PET	1	tonne	Emission factors for total plastics from Tellus (1992). Operation to the landfill from a personal communication with S. Middleton, Pacific Waste, NSW, 1998
PET	0.9	tonne	Reprocessing ends up with 0.9 tonne of reprocessed PET thereby avoiding 0.9 tonne of virgin PET production. Data from EcoInvent adapted to Australian context (energy, transport, materials).

*Data Quality table and comment*

Table 6 describes the key processes and data sources used to determine the benefits and impacts associated with the recycling of 1 tonne of PET from C&I and C&D sources. The table also includes the products and processes avoided when 1 tonne of PET is recycled.

**Table 6: Data quality for life cycle inventory data modelled for recycling and landfilling of PET from C&I and C&D source (1 tonne)**

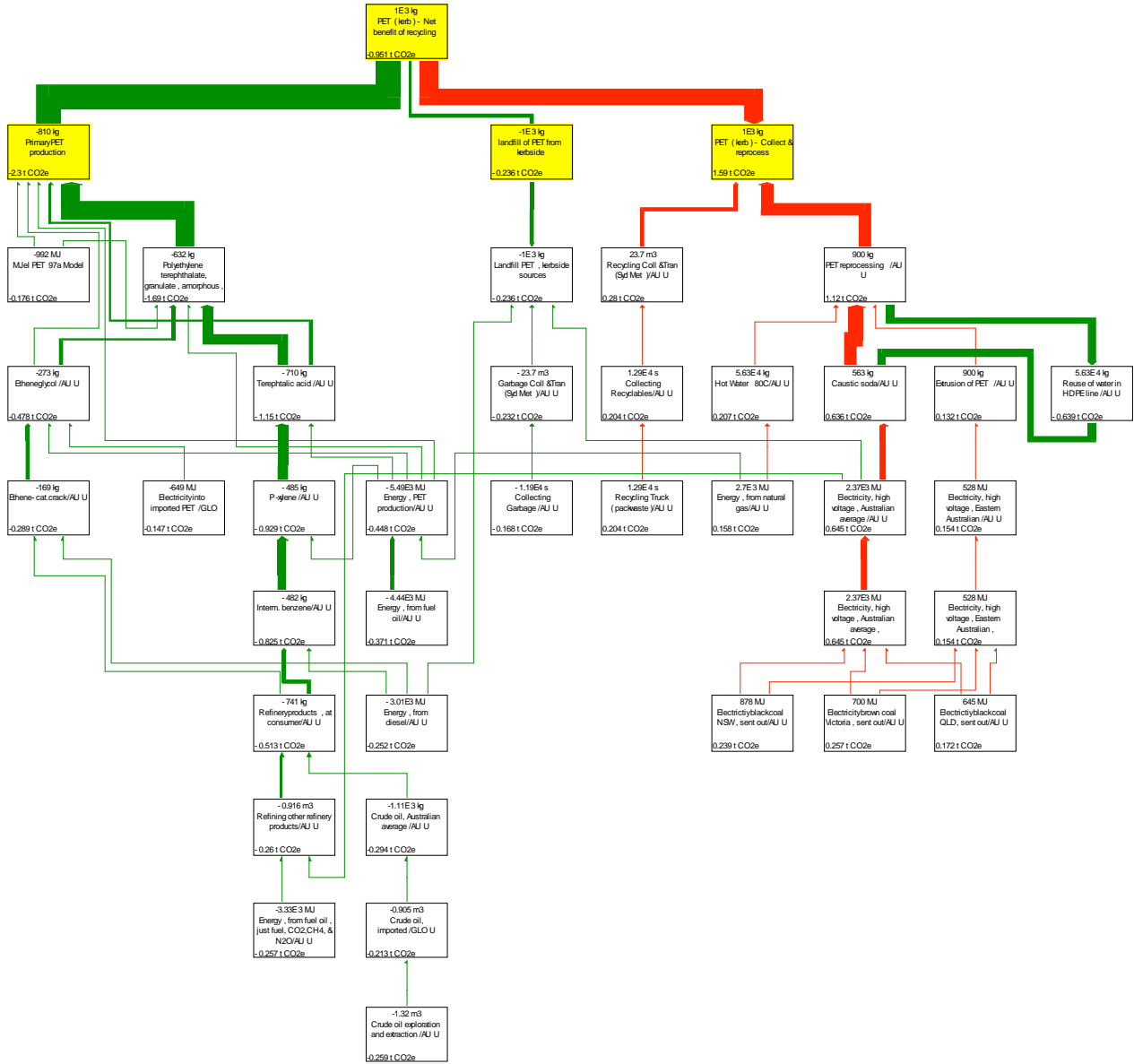
	Primary data source	Geography	Data Age	Technology	Representativeness
Impact of transport	Apelbaum consulting group (2001)	Australia	2001	Average	Average from all suppliers
Transportation distances	Estimate	Sydney	2009	Average	Estimate based on simple radial transport model
Reprocessing PET	Aggregated data: Idemat Buwal250 and Visy	Australia	2004	Unspecified	Unspecified
Avoided PET production	Adapted from Ecoinvent	European data adapted to Australian conditions	2005	Unspecified	Unspecified
Avoided landfill impacts	Tellus Institute	Australia	1999	Unspecified	Mixed Data

## References

- Apelbaum Consulting Group (2001), Australian Transport facts 2001 Tables in Excel Format, Blackburn, Victoria.
- Apelbaum (1997), Australian Transport Task, Energy consumed and Greenhouse Gas Emissions, Volume A, Summary of findings
- BUWAL 250 (1996), Ökoinventare für Verpackungen, Schriftenreihe Umwelt 250, Bern
- Delft University of Technology (1996), data from the Section for Environmental Product Development, Faculty of Industrial Design Engineering, The Netherlands
- Grant, T., James, K., Lundie, S., Sonneveld, K., (2001a), Life Cycle Assessment for Paper and Packaging Waste Management Scenarios in Victoria, EcoRecycle, Melbourne
- Grant, T., James, K.L., Lundie, S., Sonneveld, K., Beavis, P. (2001b), Report for Life Cycle Assessment for Paper and Packaging Waste Management Scenarios in New South Wales, NSW Environment Protection Authority, Sydney
- IDEMAT Software (1996), Faculty of Industrial Design Engineering, Delft University of Technology, Jaffalaan 9, 2628 BX Delft, The Netherlands
- National Greenhouse Gas Inventory Committee (1997), National Greenhouse Gas Inventory, with methodology supplements, Australian Greenhouse Office.
- National Greenhouse Gas Inventory Committee (2004), National Greenhouse Gas Inventory, with methodology supplements, Australian Greenhouse Office.
- Nishtala, S., Solano-Mora, E., (1997), Description of the Material Recovery Facilities Process Model: Design, Cost, and Life-Cycle Inventory, Research Triangle Institute and North Carolina State University
- Swiss Centre for Life Cycle Inventories. (2004). "EcoInvent Database version 1.01." from <http://www.ecoinvent.ch/en/index.htm>
- Tellus Packaging Study (1992), Assessing the impacts of production and disposal of packaging and public policy measure to alter its mix, Tellus Institute, USA
- Wang, F. (1996). Solid Waste Integrated Management Model. PhD Thesis in the Department of Chemical and Metallurgical Engineering. Melbourne, RMIT.

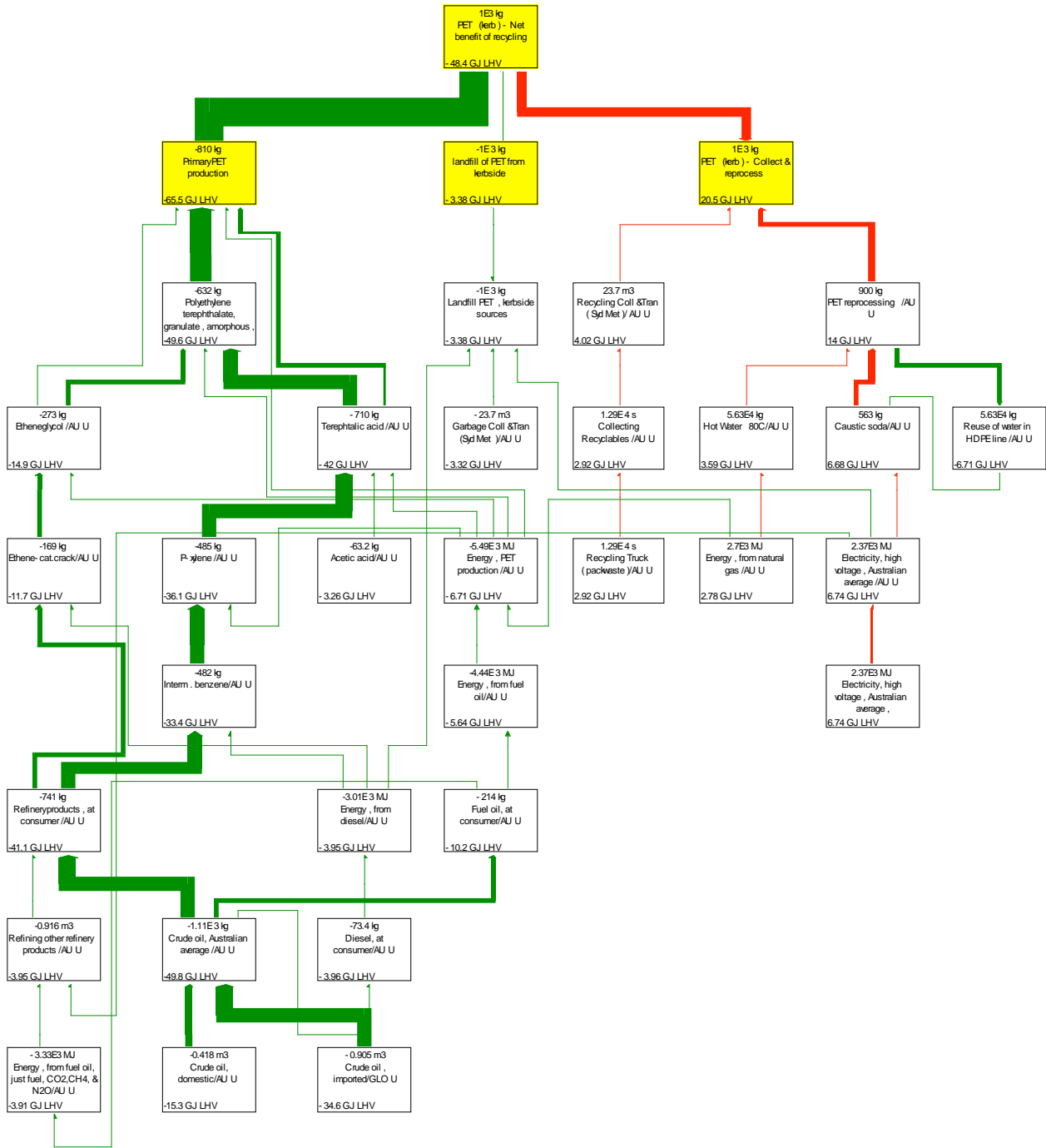
## Network diagrams — Kerbside collection

Figure 3: Recycling process network diagram — Green house gases indicator. Processes contributing less than 5 per cent to total are not shown. Major processes from results table above are shown shaded.

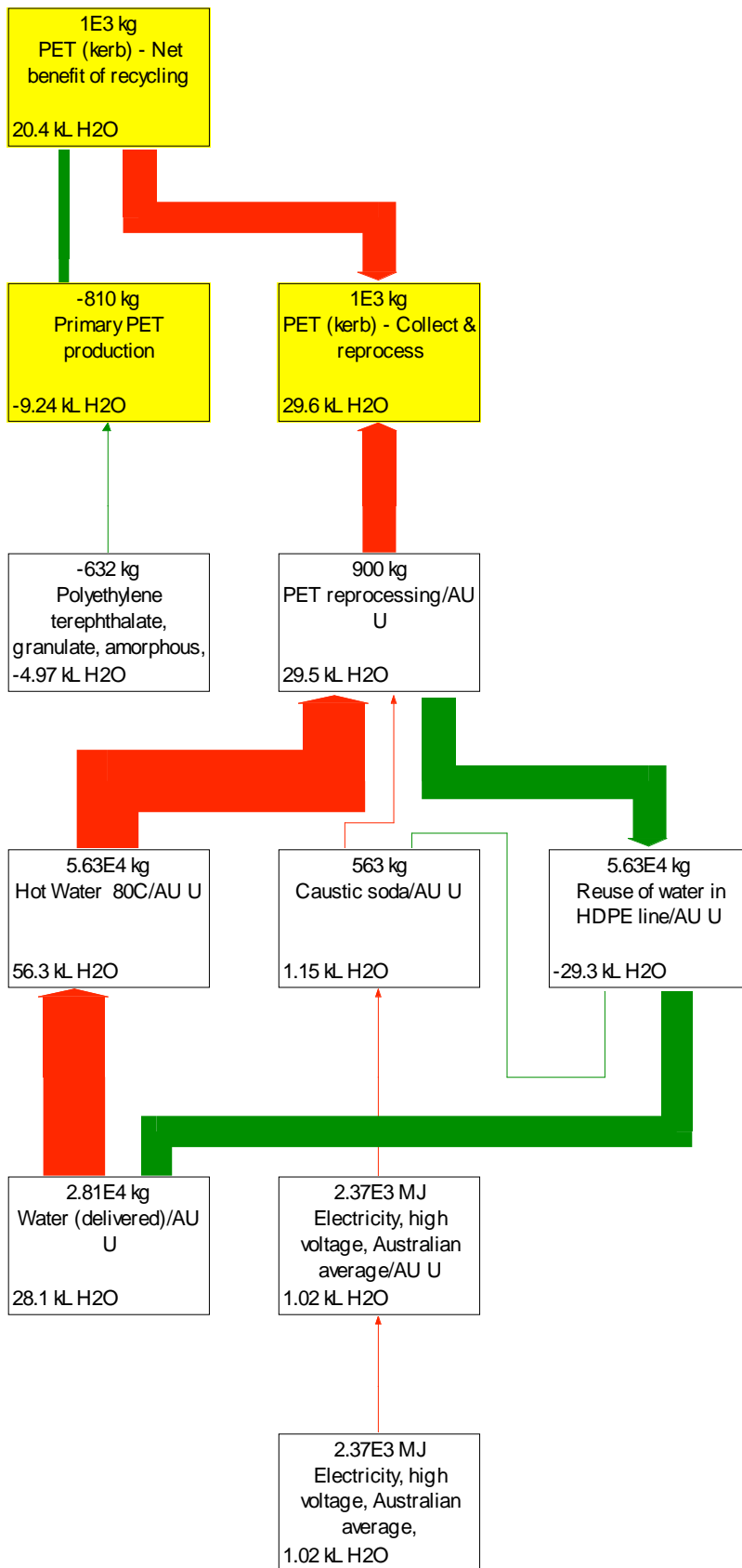




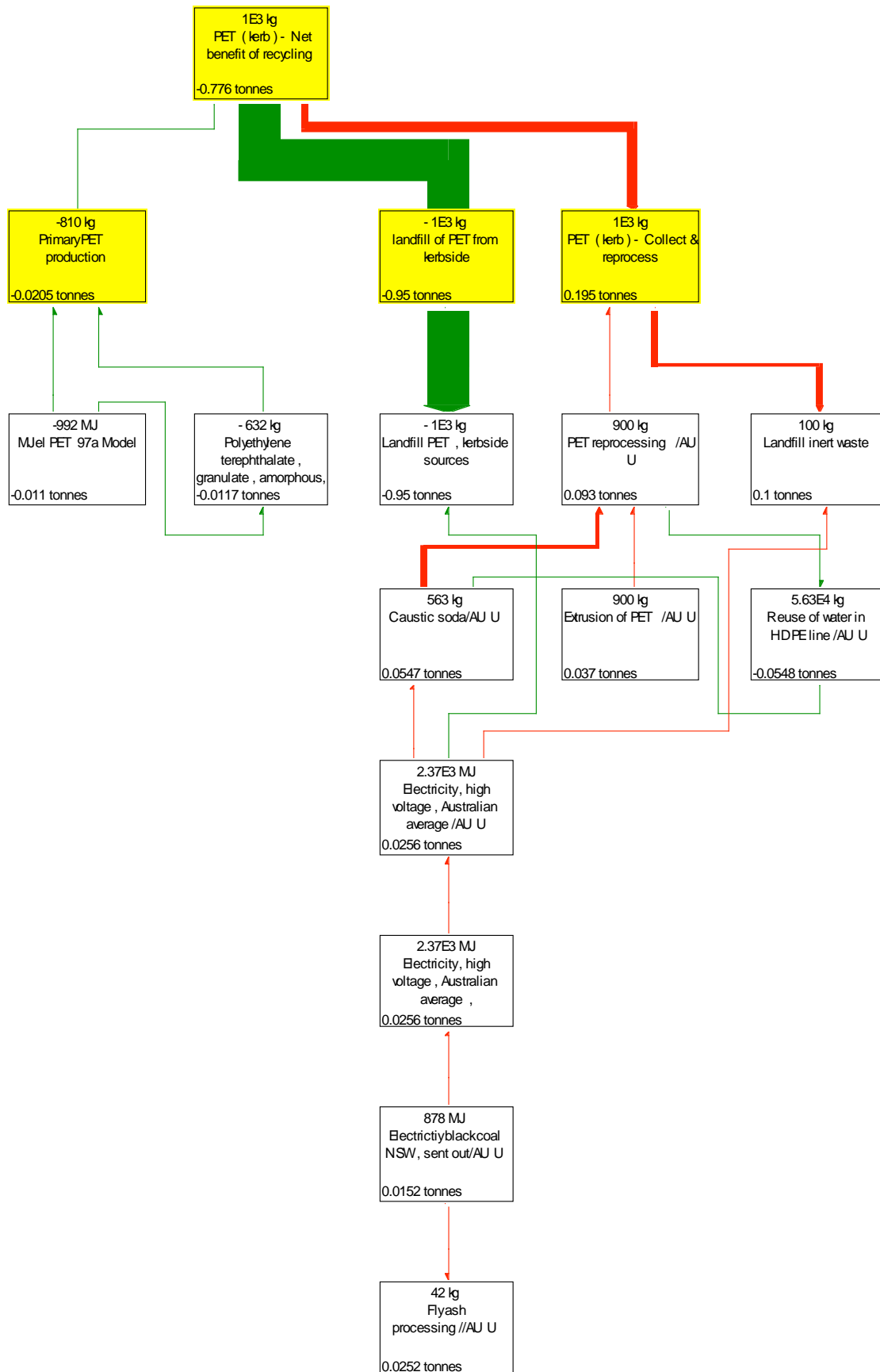
**Figure 4: Recycling process network diagram — Cumulative energy demand indicator. Processes contributing less than 4 per cent to total are not shown. Major processes from results table above are shown shaded.**



**Figure 5: Recycling process network diagram — Water indicator. Processes contributing less than 1 per cent to total are not shown. Major processes from results table above are shown shaded.**

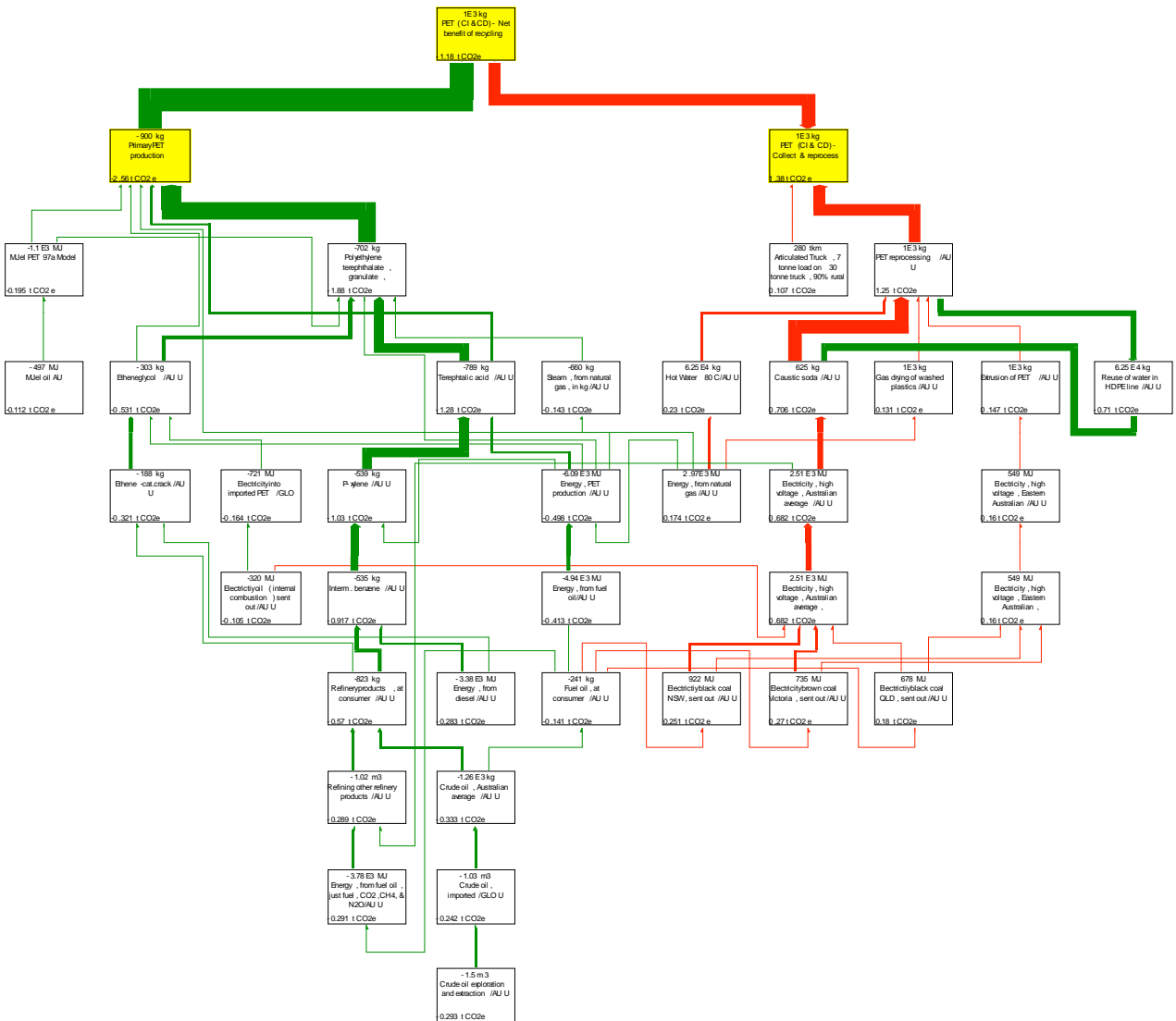


**Figure 6: Recycling process network diagram — Solid waste indicator. Processes contributing less than 1 per cent to total are not shown. Major processes from results table above are shown shaded.**

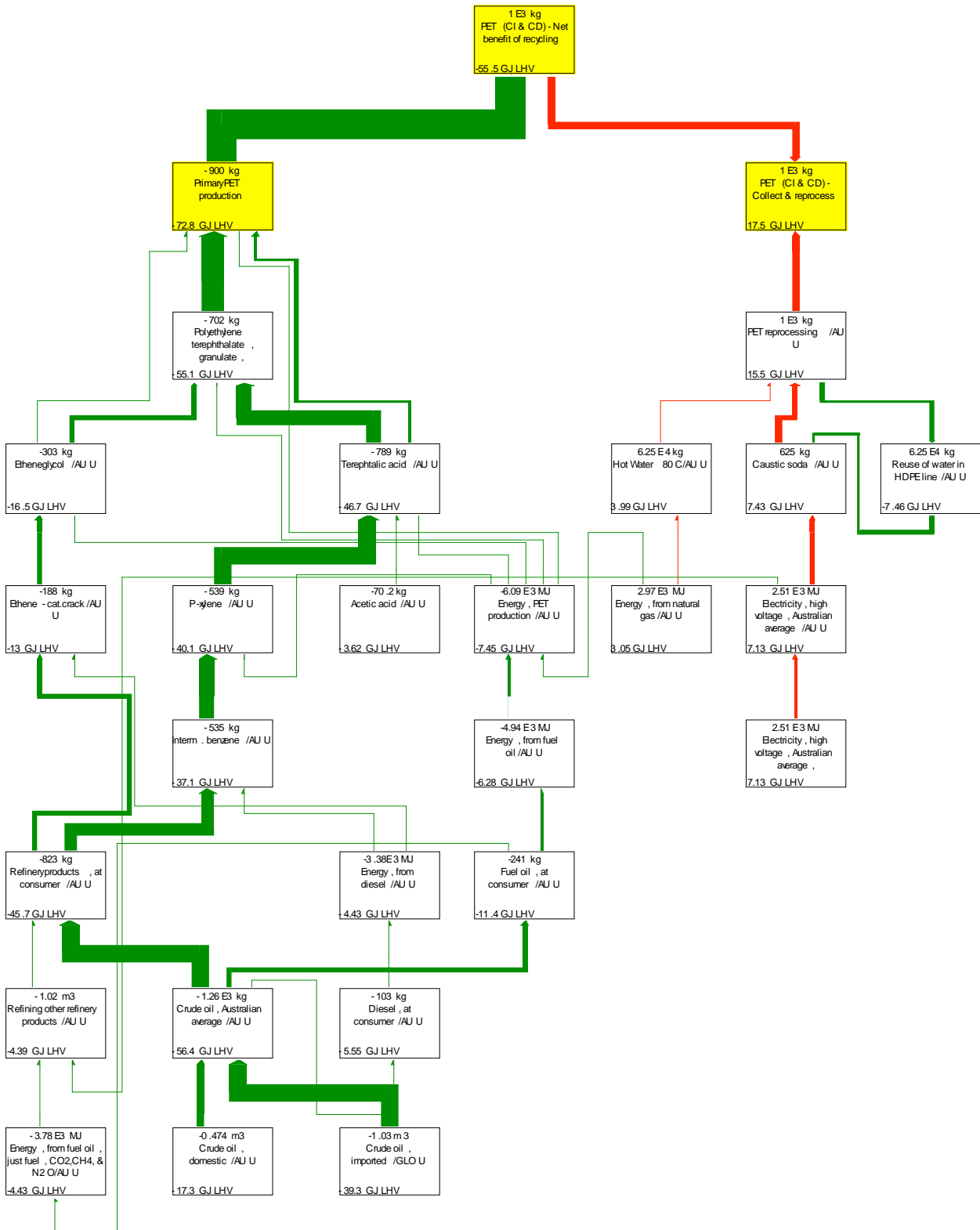


### Network diagrams — C&I and C&D collection

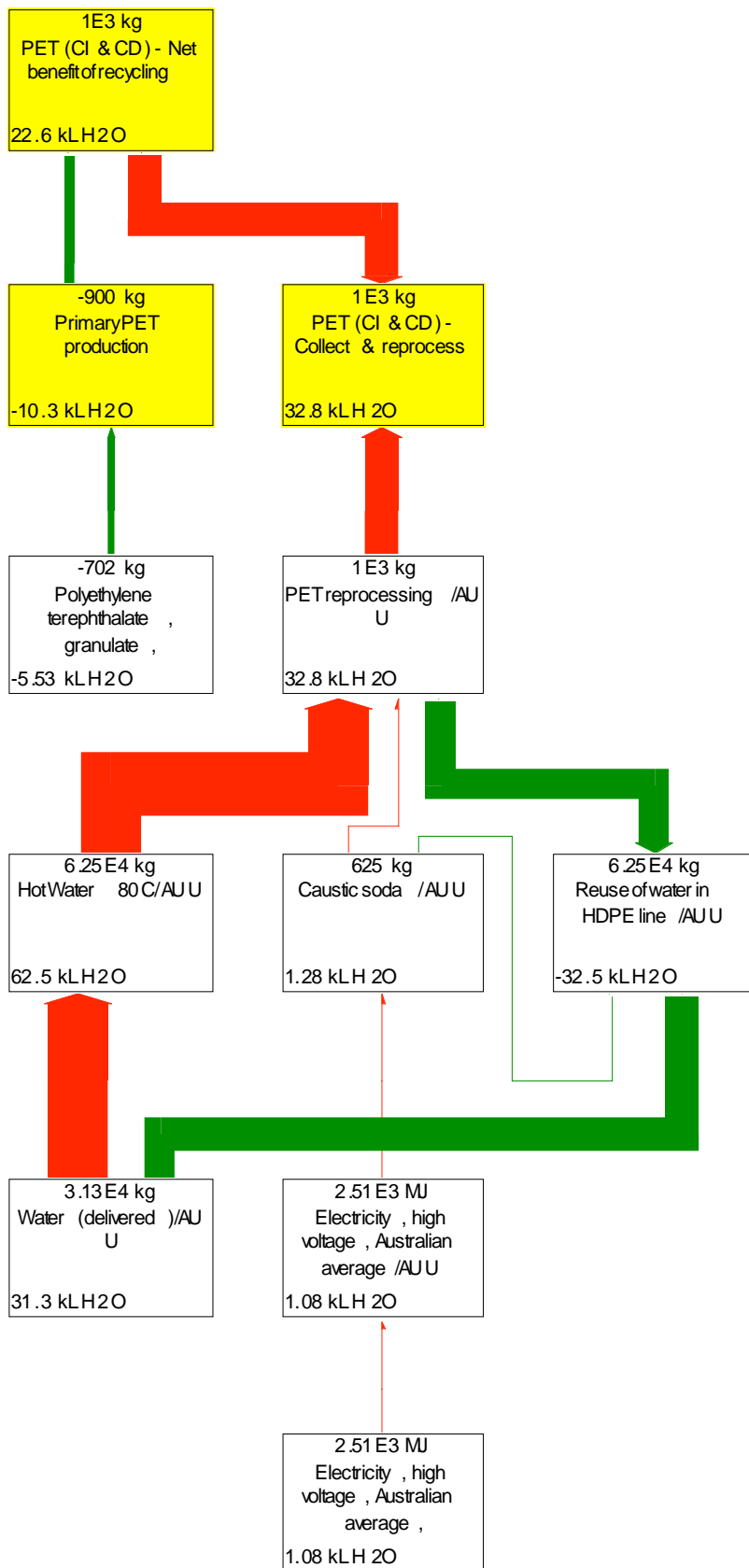
**Figure 7: Recycling process network diagram — Green house gases indicator. Processes contributing less than 4 per cent to total are not shown. Major processes from results table above are shown shaded.**



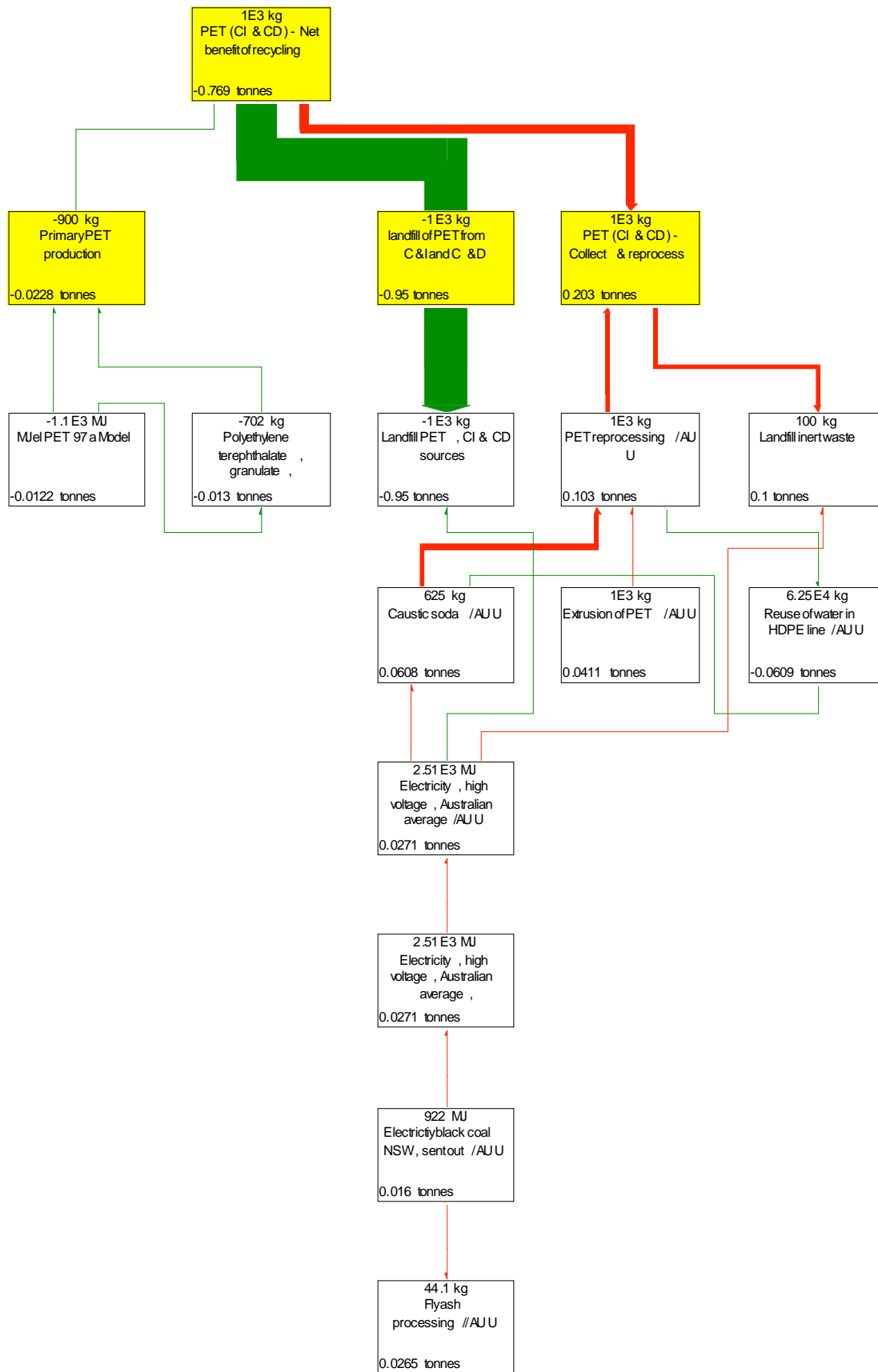
**Figure 8: Recycling process network diagram — Cumulative energy demand indicator. Processes contributing less than 4 per cent to total are not shown. Major processes from results table above are shown shaded.**



**Figure 9: Recycling process network diagram — Water indicator. Processes contributing less than 1 per cent to total are not shown. Major processes from results table above are shown shaded.**



**Figure 10: Recycling process network diagram — Solid waste indicator. Processes contributing less than 1 per cent to total are not shown. Major processes from results table above are shown shaded.**



## HDPE

### *Process Description*

High Density Polyethylene (HDPE) is a semi-crystalline polymer that can be recognized by its opaque appearance. Chemical resistance is good and can be improved further by surface treatment such as sulfonation or fluorination, or by co-extruding plastics with higher barrier properties. HDPE is commonly used for the manufacture of packaging.

In this recycling process model, HDPE is assumed to be washed and ground into granulate. This granulate can then be used as a substitute for virgin HDPE.

#### **Two collection systems for waste HDPE were considered in the model:**

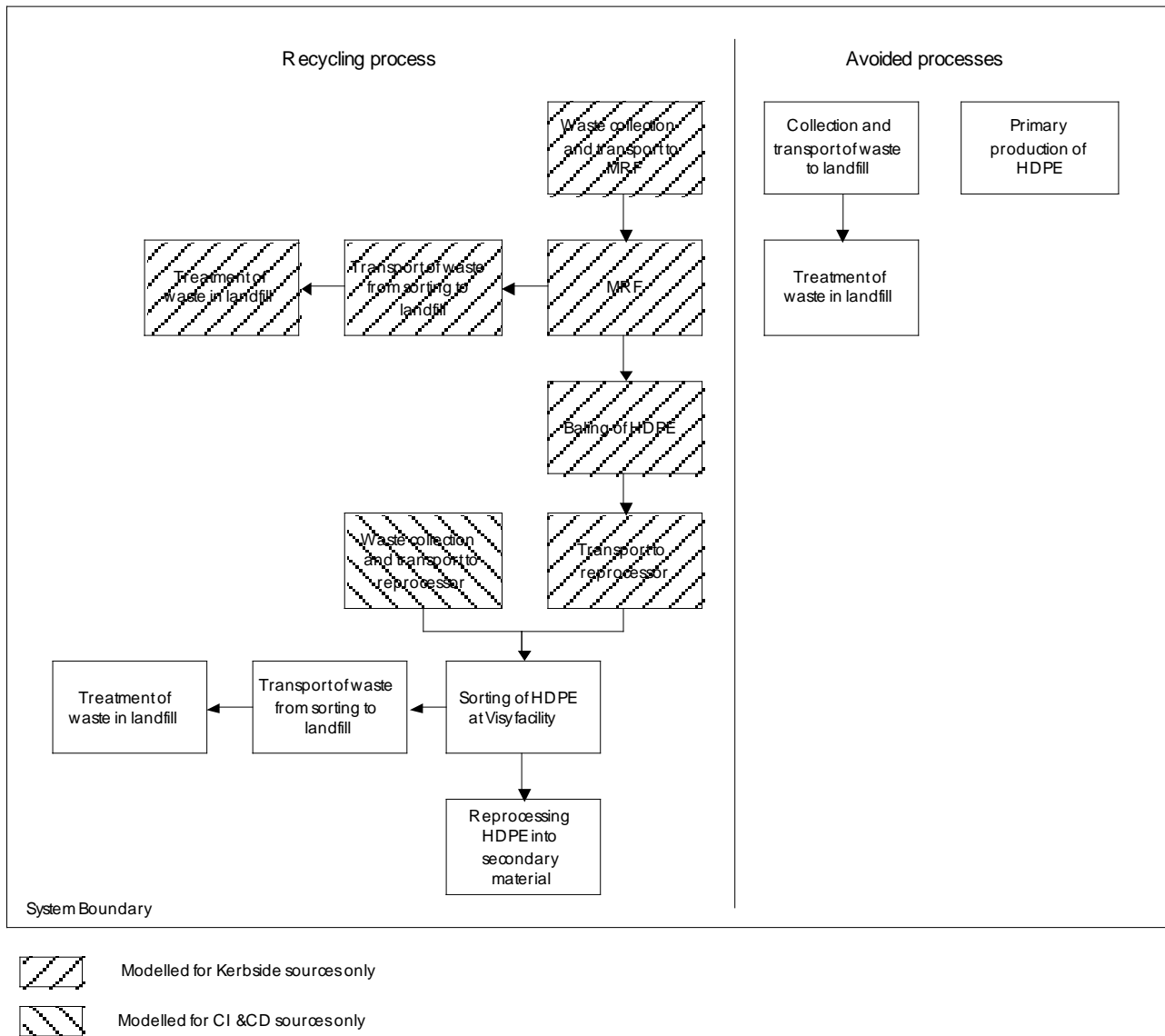
- A) A) Kerbside collection — municipal collection of HDPE in commingled from households, and processing through a Materials Recovery Facility
- B) B) C&I, C&D collection — segregated waste collected is sent directly to the reprocessing site without any sorting process, or associated losses

The unique nature of each collection system drives differences in the impacts associated with HDPE recycling. For this reason the HDPE recycling processes considered, and impacts generated, have been described separately in the following sections, according to the collection method used.

Figure 11 illustrates the processes considered in determining the overall impact of HDPE recycling from kerbside and C&I and C&D sources (shown to the left of the vertical line), and the processes considered in determining the overall impact of the avoided processes (shown to the right of the vertical line).



**Figure 11: Processes considered in determining the net impacts of the recycling process from kerbside and C&I and C&D sources.**



## A) Kerbside collection system

### *Processes considered*

The kerbside collection system involves collection of waste for recycling from the kerbside and transport to a Materials Recovery Facility (MRF), which sorts the commingled materials in the recycling stream. The model developed takes into account transportation impacts as well as sorting impacts incurred to bring the material from the kerbside to the material reprocessing facility. During sorting, waste material is generated and transported to landfill.

Once at the reprocessing facility, the model considers the impacts of material reprocessing required to convert the waste material into secondary HDPE products. Losses associated with this process are included in the analysis. The kerbside treatment system is illustrated in Figure 11 (unique system processes shaded accordingly).

In order to determine the net benefit of recycling a material, it is also necessary to consider the processes avoided when recycling is undertaken. Figure 11 also illustrates the processes that would be avoided if HDPE waste were to be recycled (shown to the right of the vertical line). Two

main avoided processes are considered; the collection and disposal to landfill of HDPE waste from the kerbside, and the primary manufacture of HDPE from virgin resources.

## Results

Considering both the recycling process flows and the avoided process flows, described in Figure 11, an inventory of environmental flows was developed. This inventory was then assessed using the Australian Impact Assessment Method, with results described in Table 7.

**Table 7: Benefits and impacts of recycling HDPE from a kerbside source (per tonne). Benefits are shown negative, impacts are shown positive.**

Impact category	Unit	Recycling process impacts (Figure 113 - left side)	Avoided process impacts (Figure 113 - right side)			Net benefits of recycling
		Collection, sorting and reprocessing	Collection and landfill	Primary material production	Total avoided impacts	
Green house gases	t CO <sub>2</sub>	1.27	-0.30	-1.80	-2.10	-0.84
Cumulative energy demand	GJ LHV	16.41	-4.32	-62.45	-66.77	-50.35
Water use	kL H <sub>2</sub> O	4.67	-0.03	-1.33	-1.36	3.31
Solid waste	tonnes	0.35	-0.95	-1.95	-2.90	-2.55

Network diagrams detailing key processes that influence the impact listed in Table 7 are shown in Figure 12 to Figure 15. For further information regarding interpretation of network diagrams, refer to Understanding Network Diagrams (Figure 1).

## Key assumptions

Table 8 describes the key processes and data sources used to determine the benefits and impacts associated with the collection, recycling and reprocessing of 1 tonne of HDPE. The table also includes the products and processes avoided when 1 tonne of HDPE is recycled.

**Table 8: Inventory for recycling 1 tonne of HDPE from a kerbside source**

Item	Flow	Unit	Comment
<b>Process flows (Figure 11 — left hand side)</b>			
Waste collection and transport to MRF	30.4	m <sup>3</sup>	27.6 m <sup>3</sup> per tonne + 2.76 m <sup>3</sup> for carrying 10 per cent non recyclables as contamination in collection, from Grant (2001a) Transport model for kerbside collection based on Grant (2001b), refer appendices for discussion on transport. Emission of the truck from NGGIC (1997)
Sorting of HDPE at Material Recovery Facility (MRF)	30.4	m <sup>3</sup>	27.6 m <sup>3</sup> per tonne + 2.76 m <sup>3</sup> for carrying 10 per cent non recyclables as contamination in collection; density of the material in cubic meter from Grant (2001a) Energy inputs from Nishtala (1997) and estimated from equipment specifications
Baling of HDPE	0.9	tonne	Assumption of 10 per cent loss after MRF (Grant, 2001b) Electricity inputs from Nishtala (1997), 12kWh per tonne.
Transport to reprocessor	20	km	HDPE waste sent to Visy Plastic Recycling (Smithfield, NSW) In consistency with the assumption made for C&I and C&D waste, 20km is used as a default value for transport. Refer appendices for transport discussion.

Item	Flow	Unit	Comment
			Fuel use data are from Apelbaum (1997). Greenhouse related emissions are based on fuel use with factors taken from NGGIC (1997). Non greenhouse emissions apart from lead are taken from Delft (1996).
Sorting of HDPE at Visy facility	0.9	tonne	A further sorting of the plastic is undertaken at the Visy plant. Data on Visy Plastics process supplied by Visy aggregated with data from Idemat (1996) 10 per cent loss during sorting at Visy plastic facility
Reprocessing HDPE into secondary material	0.81	tonne	Data supplied by Visy Plastics aggregated with data from Buwal 250
Transport of waste from sorting to landfill	20	km	Emissions from transport based on an articulated truck, 28 tonne load on 30 tonne truck. Trucking model developed from data provided by Apelbaum (2001)
Treatment of waste in landfill	190	kg	Loss from MRF and Visy Plastic factory sorting process. Emission factors for total plastics from Tellus (1992). Operation to the landfill from a personal communication with S. Middleton, Pacific Waste, NSW, 1998
<b>Avoided process (Figure 11 — right hand side)</b>			
Collection and transport of waste to landfill	30.4	m <sup>3</sup>	Waste collection avoided by sending material to MRF above. Transport model for kerbside collection based on Grant (2001b); refer appendices for discussion on transport. Emission of the truck from Apelbaum (2001), NGGIC (1997) and other sources.
Treatment of HDPE waste in landfill	1	tonne	Emission factors for total plastics from Tellus (1992). Operation to the landfill from a personal communication with S. Middleton, Pacific Waste, NSW, 1998
Primary production of HDPE	0.81	tonne	2.1 MJ of electricity consumed per tonne of HDPE processed. Inputs adapted from Chalmers University Polymerisation (1991). Corrected for Australian energy and feedstock types.

### *Data Quality table and comment*

Table 9 presents a summary of the data quality for the main processes considered. It shows the data sources used; if they are general data or specific to a company; the age of the data; the geographic location that the data were based on; and, the nature of the technology considered.

**Table 9: Data quality for life cycle inventory data modelled for recycling and landfilling of HDPE, kerbside source (1 tonne)**

	Primary data source	Geography	Data Age	Technology	Representativeness
Impact of transport	EcolInvent, NGGI, Apelbaum (1997) and Delft (1996)	European data adapted to Australian conditions and Australian data	2005	Average technology	Mixed data
Reprocessing HDPE	Visy Plastics, Idemat (1996), Buwal 250	Europe, Western	2004 revised	Average technology	Mixed data
Avoided HDPE production	Adapted from Chalmers University Polymerisation data 1991.	European data adapted to Australian conditions	Mixed Data (generated 1993)	Average technology	Average from processes with similar outputs
Avoided landfill impacts	Tellus Institute	Australia	1999	Unspecified	Mixed Data

## B) C&I and C&D collection system

### *Processes considered*

In the case of the C&I and C&D collection system, it has been assumed that waste collected from such sources is directly sent to the reprocessing site without any further sorting process, or associated losses. The model developed takes into account transportation impacts incurred to bring the material from C&I and C&D sources to the material reprocessing facility.

Once at the reprocessing facility, the model considers the impacts of material reprocessing required to convert the waste material into secondary HDPE. Losses associated with this process are included in the analysis. The model also illustrates the processes considered in determining the impact of the processes avoided when recycling HDPE from C&I and C&D sources. Three main processes are considered, the collection of HDPE waste and landfill treatment, and the primary manufacture of HDPE from virgin resources. The system is described in Figure 11 (unique processes shaded accordingly).

### *Results*

Considering both the recycling process flows and the avoided process flows, described in Figure 11, an inventory of environmental flows was developed. This inventory was then assessed using the Australian Impact Assessment Method, with results described in Table 10.

**Table 10: Benefits and impacts of recycling HDPE from C&I and C&D sources (per tonne). Benefits are shown negative, impacts are shown positive.**

Impact category	Unit	<u>Recycling process impacts</u> (Figure 113 - left side)	<u>Avoided process impacts</u> (Figure 113 - right side)			<u>Net benefits of recycling</u>
		Collection, sorting and reprocessing	Collection and landfill	Primary material production	Total avoided impacts	
Green house gases	t CO <sub>2</sub>	0.93	-0.01	-2.00	-2.01	-1.08
Cumulative energy demand	GJ LHV	11.60	-0.13	-69.39	-69.52	-57.92
Water use	kL H <sub>2</sub> O	5.06	0.00	-1.47	-1.48	3.58
Solid waste	tonnes	0.28	-0.95	-2.16	-3.11	-2.84

Network diagrams detailing key processes that influence the impacts listed in Table 10 are shown in Figure 16 to Figure 19. For further information regarding interpretation of network diagrams, refer to Understanding Network Diagrams (Figure 1).

### Key assumptions

Table 11 describes the key processes and data sources used to determine the benefits and impacts associated with the collection, recycling and reprocessing of 1 tonne of HDPE from C&I, C&D sources. The table also includes the products and processes avoided when 1 tonne of HDPE is recycled.

**Table 11: Inventory for recycling 1 tonne of HDPE from C&I and C&D source**

Item	Flow	Unit	Comment
<b>Process flows (Figure 11 — left hand side)</b>			
Waste collection and transport to reprocessor	20	km	20km distance estimate based on a simplified transport analysis for Sydney. Refer transport discussion below. Emissions from transport based on a trucking model developed by the Centre for Design, incorporating trucking data from Apelbaum (2001) and other sources. Truck backhaul ratio assumed to be 1:2.
Sorting of HDPE at Visy facility	1	tonne	Data on Visy Plastics process supplied by Visy aggregated with data from Idemat (1996) 10 per cent loss during sorting at Visy plastic facility
Reprocessing of HDPE into secondary material	0.9	tonne	Data supplied by Visy Plastics aggregated with data from Buwal 250. Although many reprocessors of C&I,C&D waste plastics will not utilize the Visy process, it is assumed that some degree of plastics sorting and waste generation will occur, even from segregated waste streams. This process stage is retained to simulate the associated sorting impacts.
Transport of waste from sorting to landfill	20	km	Emissions from transport based on an articulated truck, 28 tonne load on 30 tonne truck. Trucking model developed from data provided by Apelbaum (2001)
Treatment of waste in landfill	100	kg	Data supplied by Visy Plastics aggregated with data from Buwal 250 Loss from Visy Plastic factory sorting process. Emission factors for total plastics from Tellus (1992). Operation to the landfill from a personal communication with S. Middleton, Pacific Waste, NSW, 1998

Item	Flow	Unit	Comment
<b>Avoided process (Figure 11 – right hand side)</b>			
Collection and transport of waste to landfill	20	km	20km distance estimate based on a simplified transport analysis for Sydney, refer appendices for discussion on transport. Emissions from transport based on a trucking model developed by the Centre for Design, incorporating trucking data from Apelbaum (2001), Truck backhaul ratio assumed to be 1:2.
Treatment of waste in landfill	1	tonne	Emission factors for total plastics from Tellus (1992). Operation to the landfill from a personal communication with S. Middleton, Pacific Waste, NSW, 1998
Primary production of HDPE	0.9	tonne	2.1 MJ of electricity consumed per tonne of HDPE processed. Inputs adapted from Chalmers University Polymerisation (1991). Corrected for Australian energy and feedstock types.

*Data quality table and comment*

Table 12 presents a summary of the data quality for the main processes considered. It shows the data sources used; if they are general data or specific to a company; the age of the data; the geographic location that the data were based on; and, the nature of the technology considered.

**Table 12: Data quality for life cycle inventory data modelled for recycling and landfilling of HDPE from C&I and C&D source (1 tonne)**

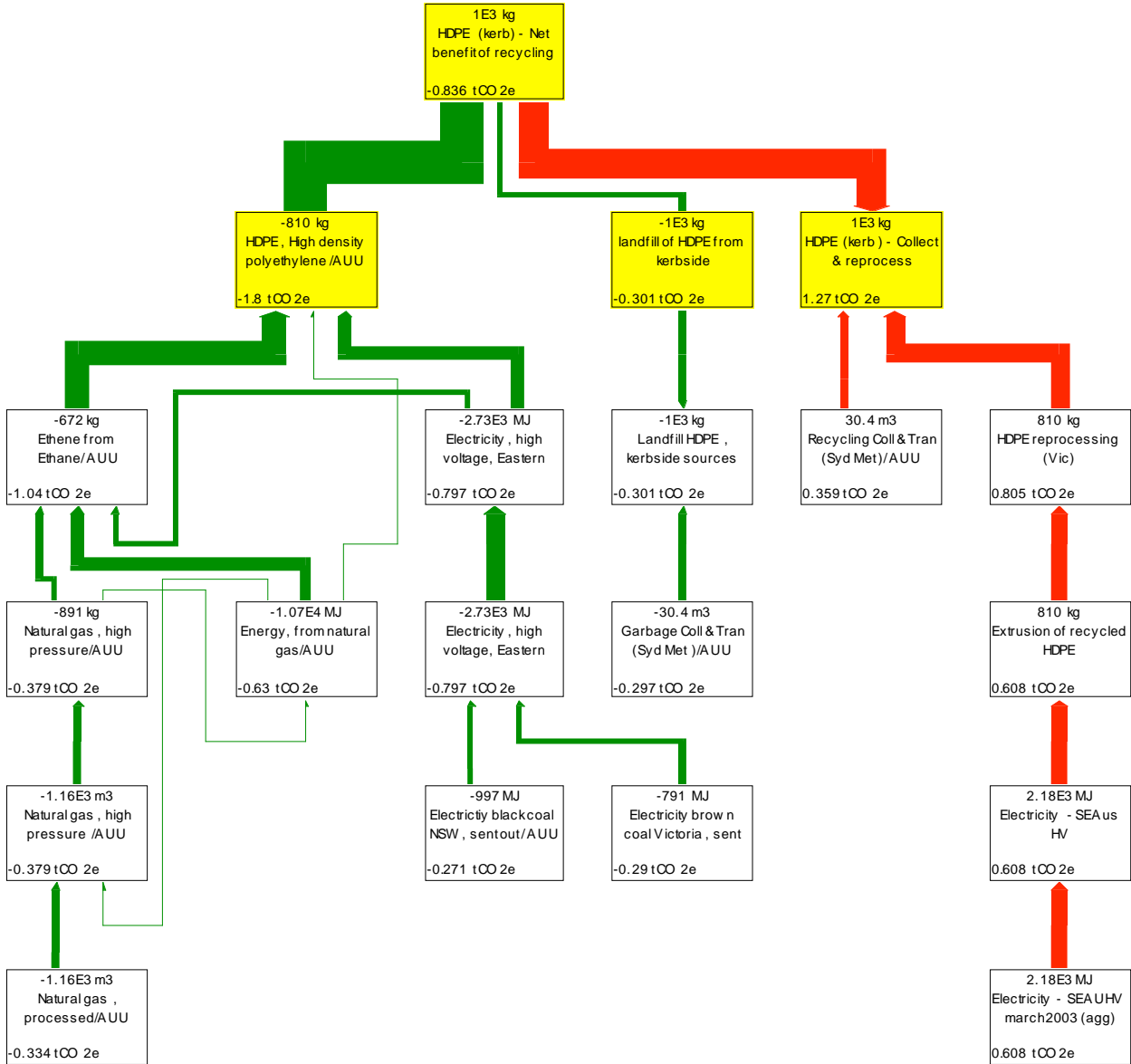
	Primary data source	Geography	Data Age	Technology	Representativeness
Impact of transport	Apelbaum consulting group (2001)	Australia	2001	Average	Average from all suppliers
Transportation distances	Estimate	Sydney	2009	Average	Estimate based on simple radial transport model
Reprocessing HDPE	Visy Plastics, Idemat (1996), Buwal 250	Europe, Western	2004 revised	Average technology	Mixed data
Avoided HDPE production	Adapted from Chalmers University Polymerisation data 1991.	European data adapted to Australian conditions	Mixed Data (generated 1993)	Average technology	Average from processes with similar outputs
Avoided landfill impacts	Tellus Institute	Australia	1999	Unspecified	Mixed Data

## References

- Apelbaum (1997), Australian Transport Task, Energy consumed and Greenhouse Gas Emissions, Volume A, Summary of findings
- BUWAL 250 (1996), Ökoinventare für Verpackungen, Schriftenreihe Umwelt 250, Bern
- Delft University of Technology (2001), Idemat database
- Delft University of Technology (1996), data from the Section for Environmental Product Development, Faculty of Industrial Design Engineering, The Netherlands
- Grant, T., James, K., (2005), Life Cycle Impact Data for resource recovery from C&I and C&D waste in Victoria final report, Melbourne, Victoria, Centre for Design at RMIT university ([www.cfd.rmit.edu.au](http://www.cfd.rmit.edu.au))
- Grant, T., James, K., Lundie, S., Sonneveld, K., (2001a), Life Cycle Assessment for Paper and Packaging Waste Management Scenarios in Victoria, EcoRecycle, Melbourne
- Grant, T., James, K.L., Lundie, S., Sonneveld, K., Beavis, P. (2001b), Report for Life Cycle Assessment for Paper and Packaging Waste Management Scenarios in New South Wales, NSW Environment Protection Authority, Sydney
- Nishtala, S., Solano-Mora, E., (1997), Description of the Material Recovery Facilities Process Model: Design, Cost, and Life-Cycle Inventory, Research Triangle Institute and North Carolina State University
- Swiss Centre for Life Cycle Inventories. (2004). "Ecolnvent Database version 1.01." from <http://www.ecoinvent.ch/en/index.htm>
- Tillman, C.S. (1991), Packaging and the environment, Chalmers Industriteknik, Goteborg Sweden
- Tellus Institute (1992), Tellus Packaging Study, for the Council of State Governments, US EPA and New Jersey Department of Environmental Protection and Energy
- Wang, F. (1996). Solid Waste Integrated Management Model. PhD Thesis in the Department of Chemical and Metallurgical Engineering. Melbourne, RMIT.

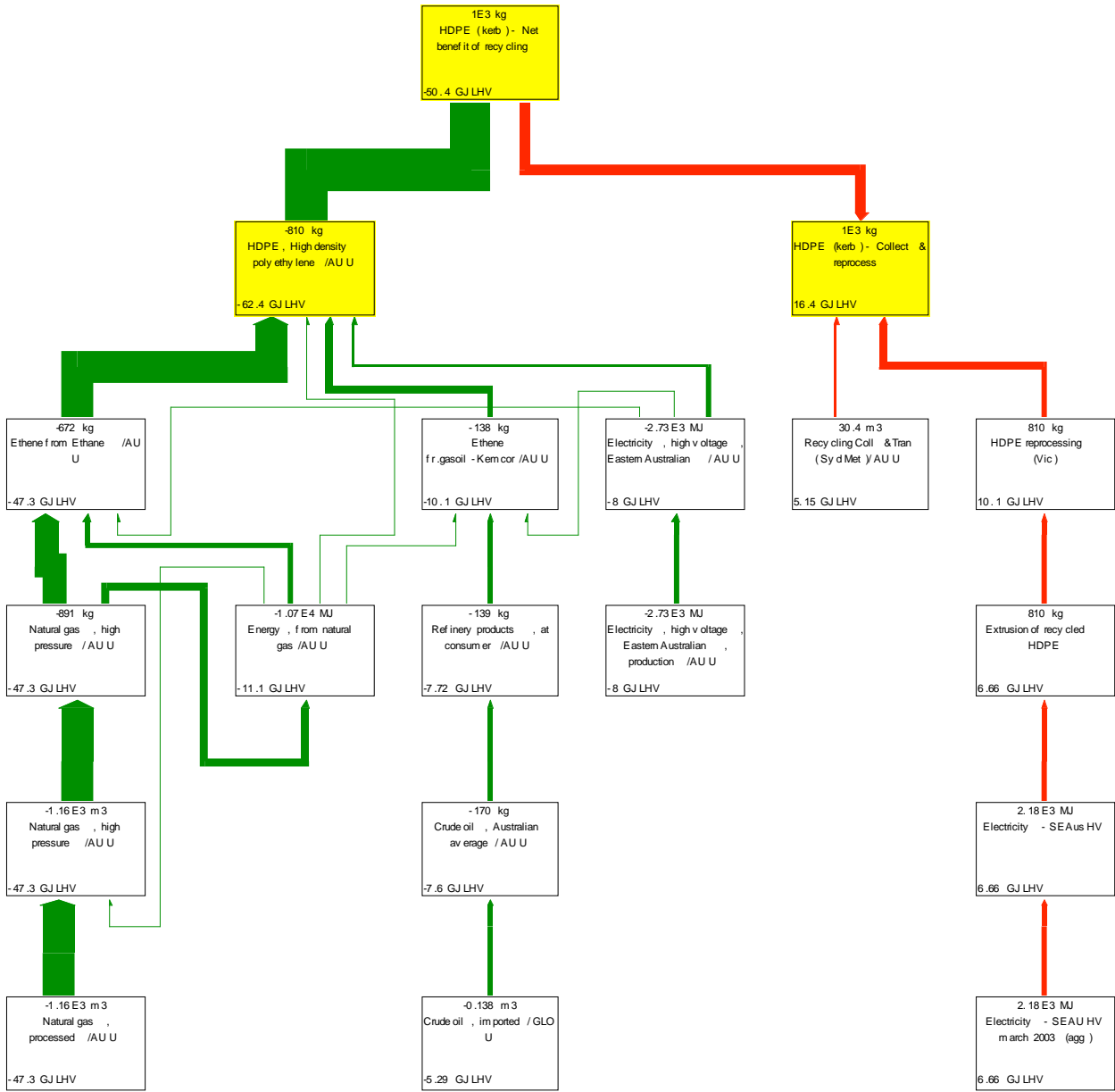
### Network diagrams — Kerbside collection

Figure 12: Recycling process network diagram — Green house gases indicator. Processes contributing less than 15 per cent to total are not shown. Major processes from results table above are shown shaded.

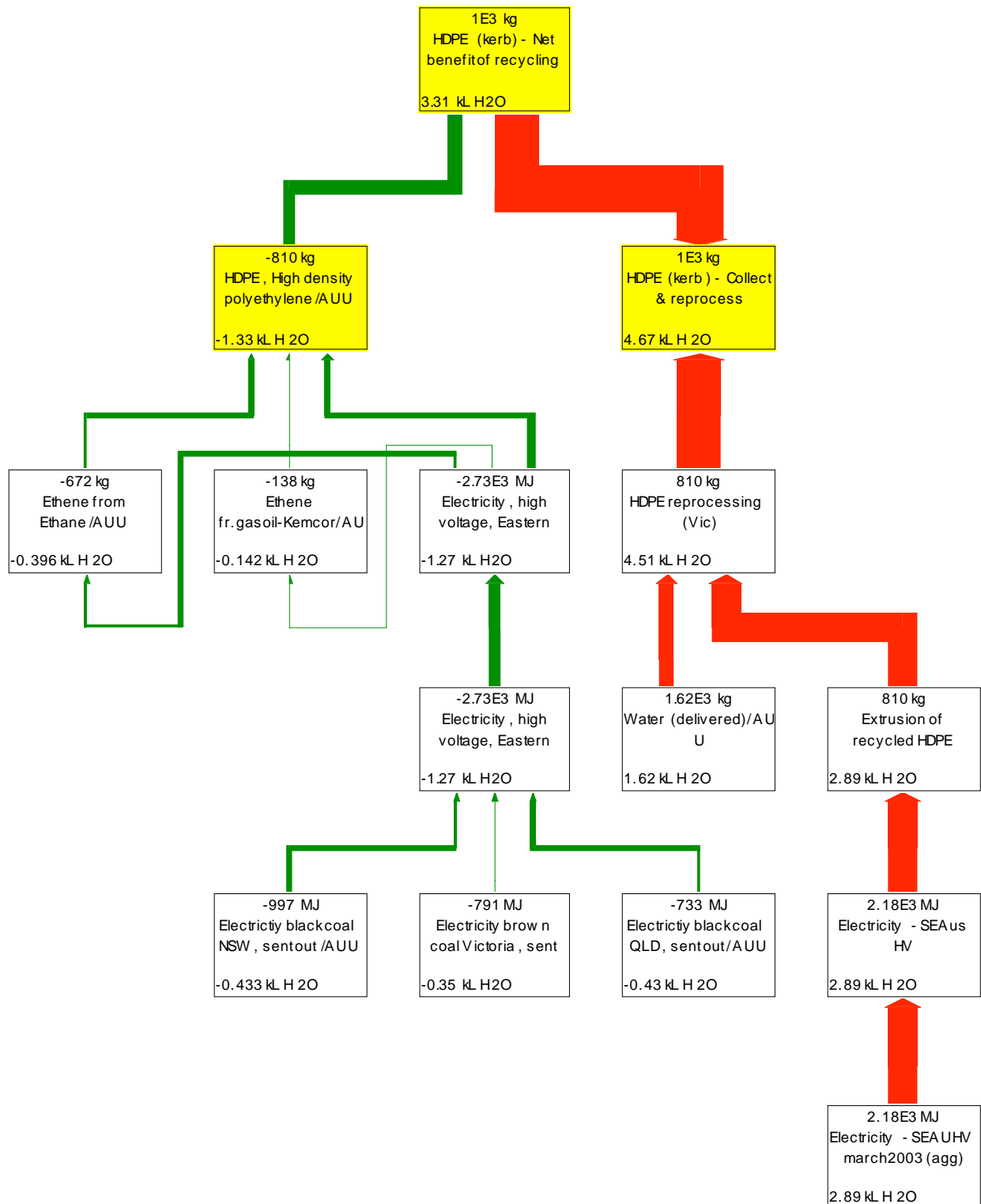




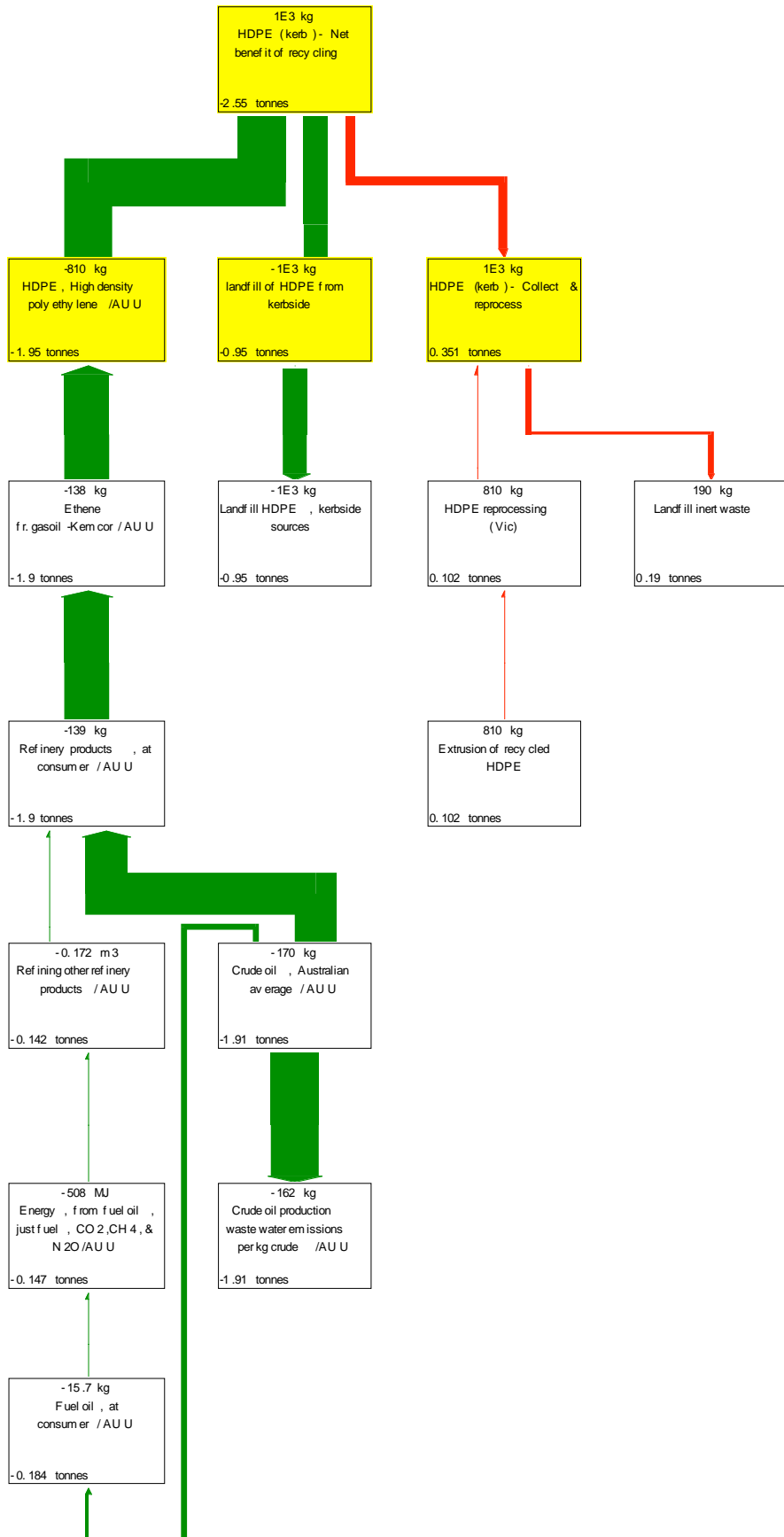
**Figure 13: Recycling process network diagram — Cumulative energy demand indicator. Processes contributing less than 7 per cent to total are not shown. Major processes from results table above are shown shaded.**



**Figure 14: Recycling process network diagram — Water indicator. Processes contributing less than 3 per cent to total are not shown. Major processes from results table above are shown shaded.**

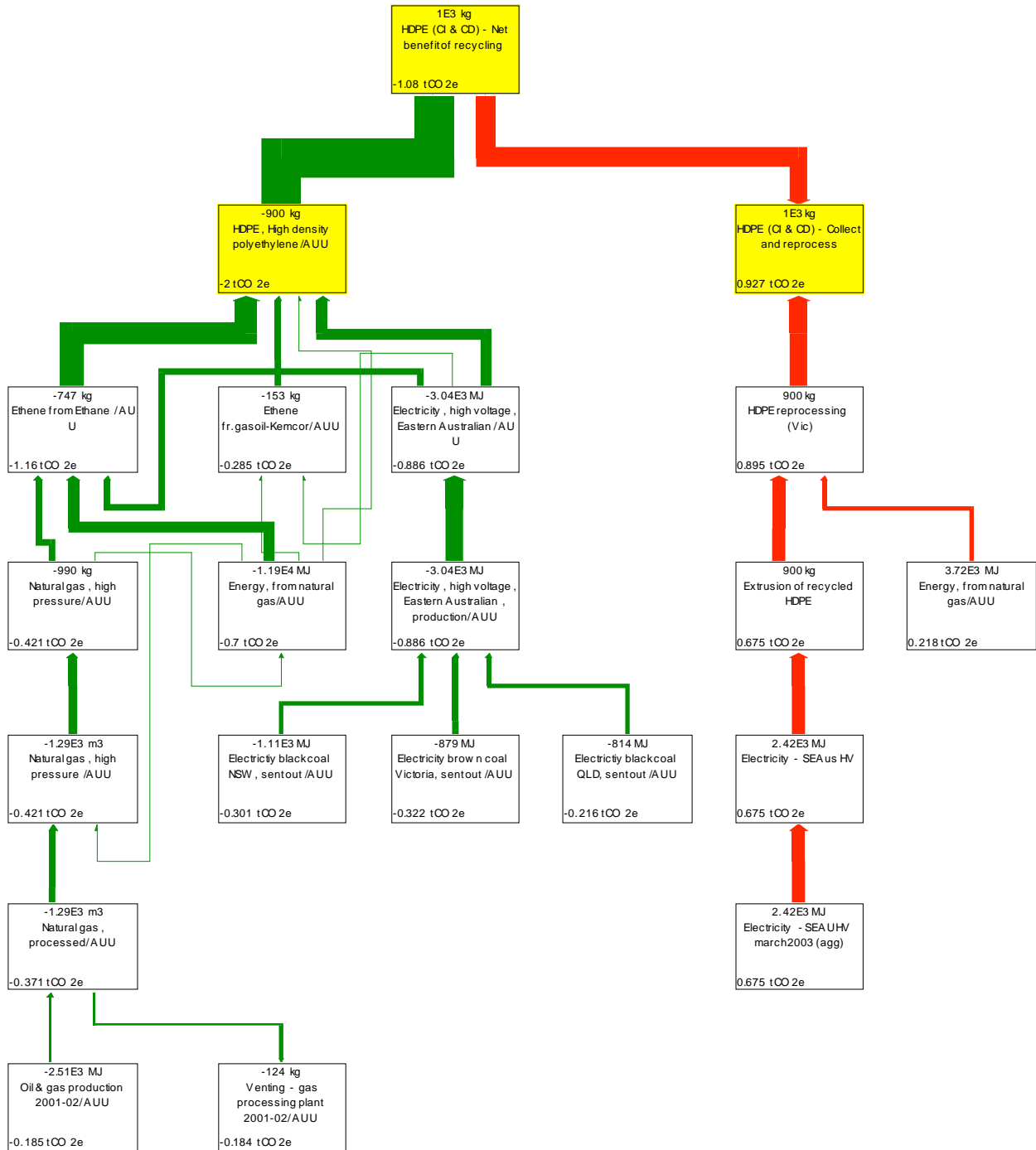


**Figure 15: Recycling process network diagram — Solid waste indicator. Processes contributing less than 1 per cent to total are not shown. Major processes from results table above are shown shaded.**

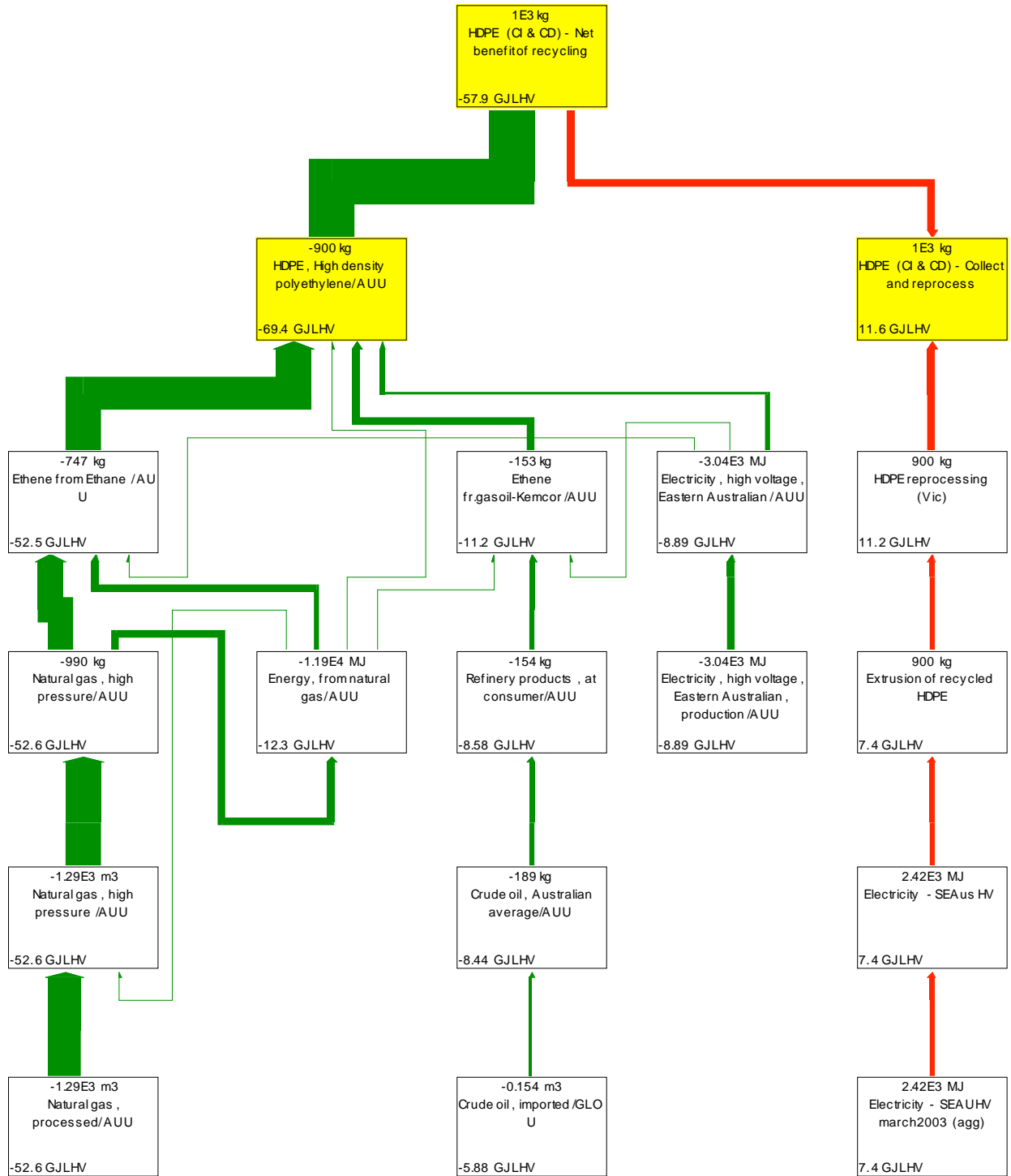


## Network diagrams — C&I and C&D collection

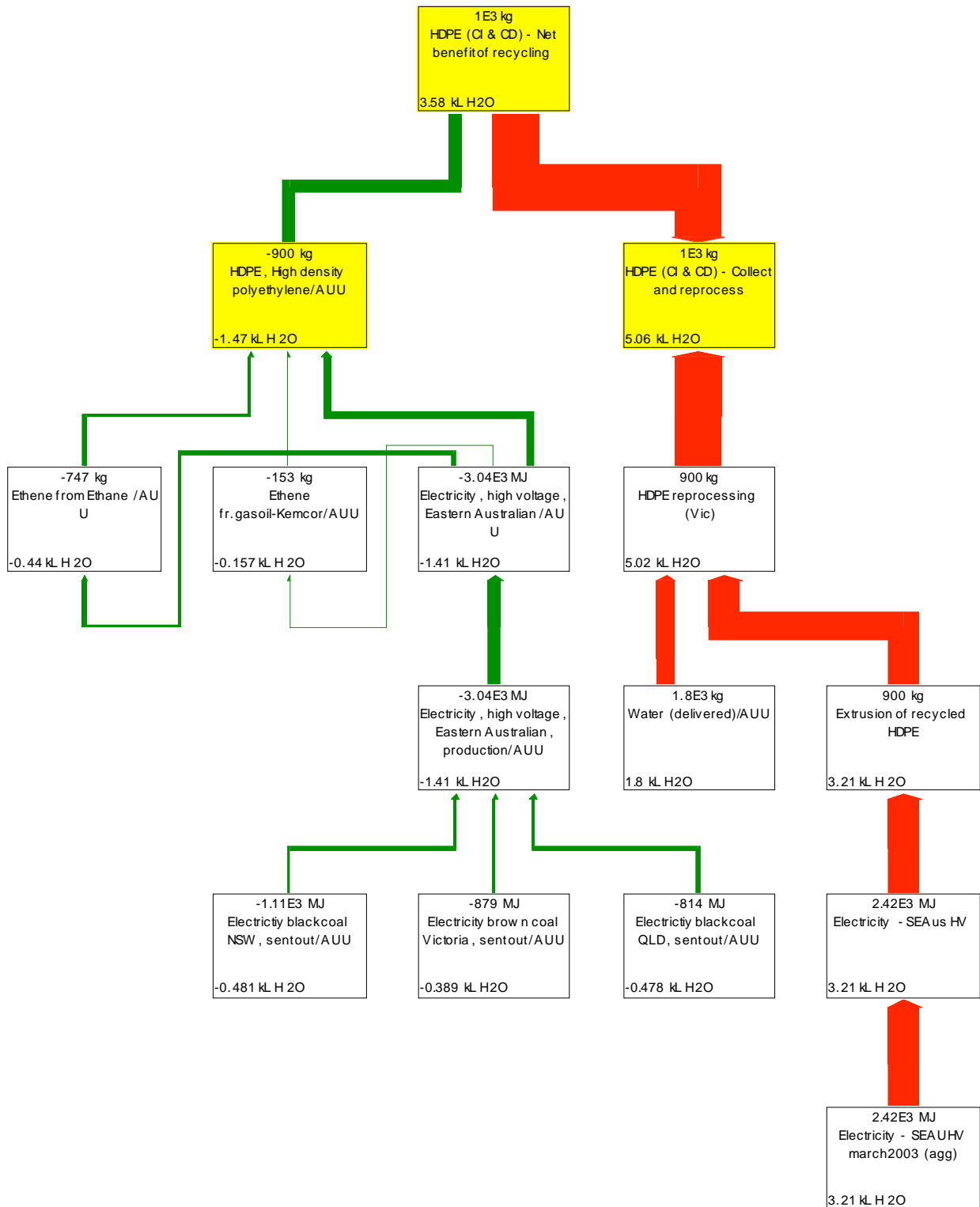
**Figure 16: Recycling process network diagram — Green house gases indicator. Processes contributing less than 6 per cent to total are not shown. Major processes from results table above are shown shaded.**



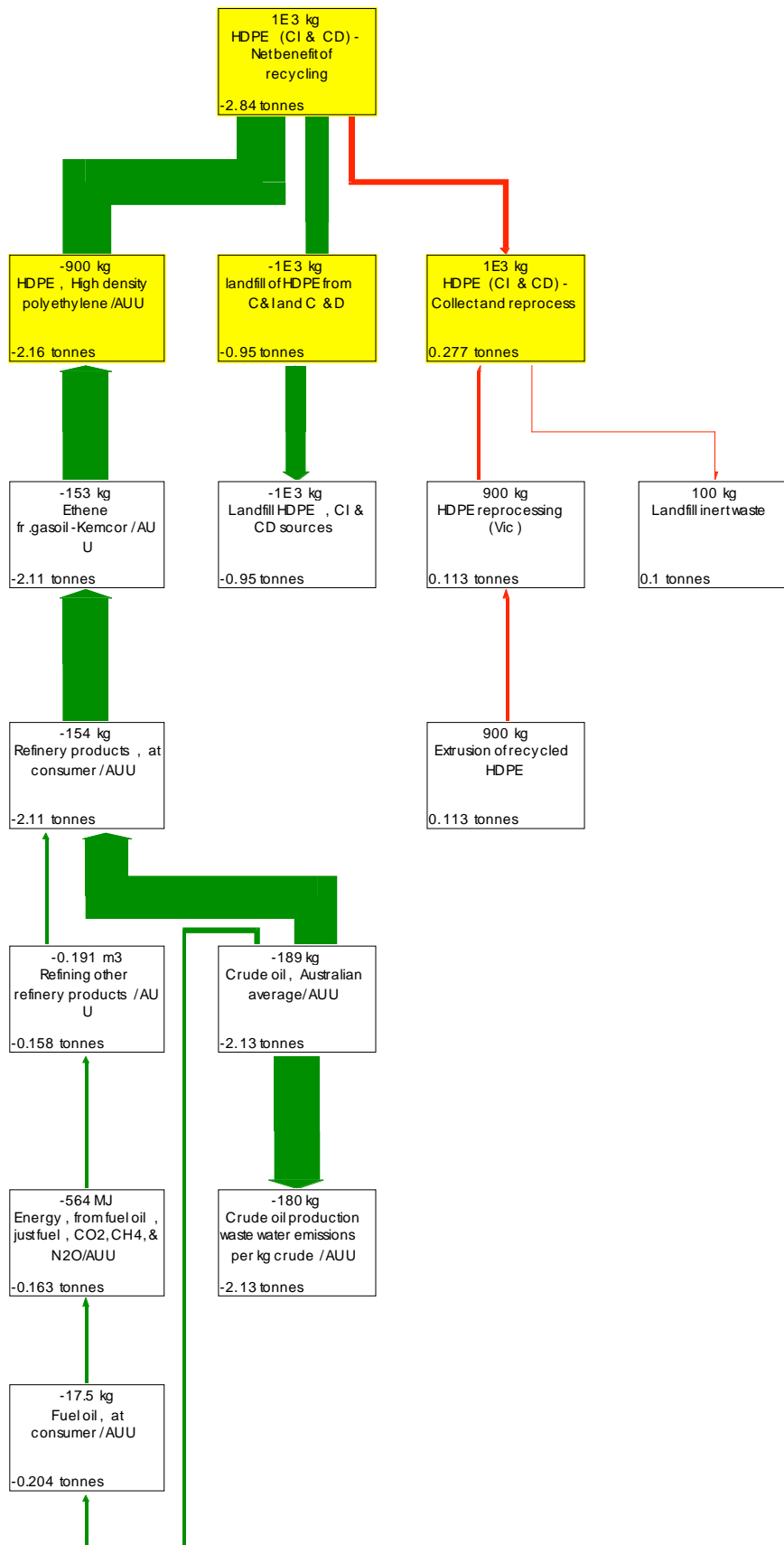
**Figure 17: Recycling process network diagram — Cumulative energy demand indicator. Processes contributing less than 6 per cent to total are not shown. Major processes from results table above are shown shaded.**



**Figure 18: Recycling process network diagram — Water indicator. Processes contributing less than 3 per cent to total are not shown. Major processes from results table above are shown shaded.**



**Figure 19: Recycling process network diagram — Solid waste indicator. Processes contributing less than 3 per cent to total are not shown. Major processes from results table above are shown shaded.**



## PVC

### *Process description*

PolyVinyl Chloride (PVC) is one of the most widely used thermoplastic polymers, and can be made into a rigid or a flexible material. It can be used in various applications such as construction (80 per cent of the PVC market (John Scheirs, 2003)), or the packaging market. A number of companies are recycling PVC in Australia — for the purposes of this study we have assumed that a process similar to that used by Cryogrind is employed. Cryogrind is employing a process that involves grinding the waste into flakes, followed by a flotation process which is used to remove contaminants (PE and PP). A cryogenic process is then used to remove PET contaminants. The result of this process is a pure PVC powder that can be used as a substitute for virgin PVC. The replacement ratio is one to one, after taking into account the losses during sorting and cleaning of used PVC.

#### **Two collection systems for PVC waste were considered in the model:**

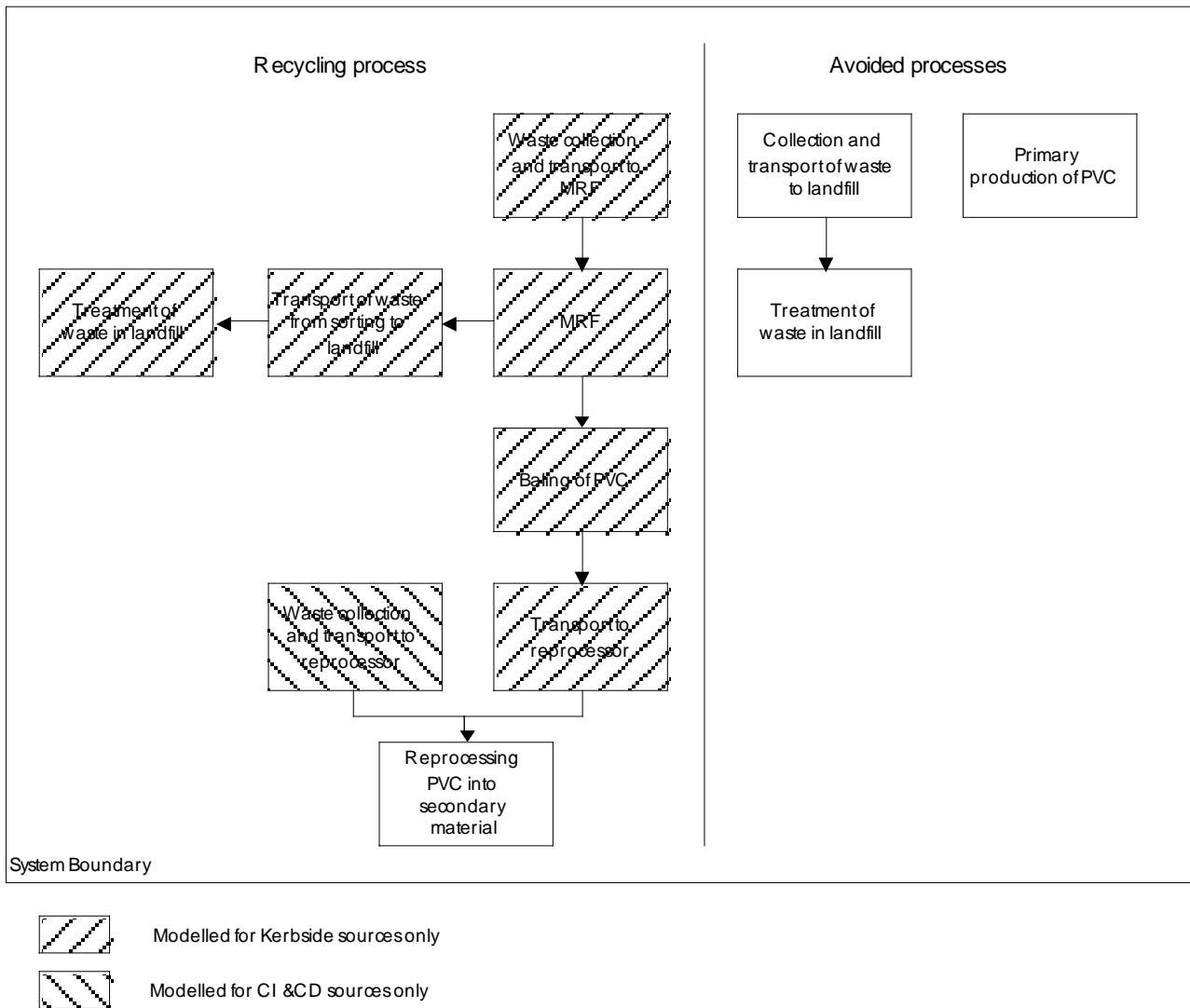
- A) Kerbside collection — municipal collection of commingled PVC from households, and processing through a Materials Recovery Facility (MRF)
- B) C&I and C&D collection — segregated waste collected is sent directly to the reprocessing site without any sorting process, or associated losses.

The unique nature of each collection system drives differences in the impacts associated with PVC recycling. For this reason the PVC recycling processes considered and impacts generated have been described separately in the following sections, according to the collection method used.

Figure 20 illustrates the processes considered in determining the overall impact of PVC recycling from kerbside and C&I and C&D sources (shown to the left of the vertical line), and the processes considered in determining the overall impact of the avoided processes (shown to the right of the vertical line).



**Figure 20: Processes considered in determining the net impacts of the recycling process from kerbside and C&I and C&D sources.**



## A) Kerbside collection system

### Processes considered

The kerbside collection system involves collection of waste for recycling from the kerbside and transport to a Materials Recovery Facility (MRF), which sorts the commingled materials in the recycling stream. The model developed takes into account transportation impacts as well as sorting impacts incurred to bring the material from the kerbside to the material reprocessing facility. During sorting, waste material is generated and transported to landfill.

Once at the reprocessing facility, the model considers the impacts of material reprocessing required to convert the waste material back into PVC granulate. Losses associated with this process are included in the analysis. The kerbside treatment system is illustrated in Figure 20 (processes unique to kerbside collection have been shaded accordingly).

In order to determine the net benefit of recycling a material, it is also necessary to consider the processes avoided when recycling is undertaken. Figure 20 also illustrates the processes that would be avoided if waste PVC was to be recycled (shown to the right of the vertical line). Two main avoided processes are considered; the collection and disposal to landfill of waste PVC from the kerbside, and the primary manufacture of PVC from virgin resources.

## Results

Considering both the recycling process flows and the avoided process flows, described in Figure 20, an inventory of environmental flows was developed. This inventory was then assessed using the Australian Impact Assessment Method, with results described in Table 13.

**Table 13: Benefits and impacts of recycling PVC from a kerbside source (per tonne)**

Impact category	Unit	Recycling process impacts (Figure 122 - left side)	Avoided process impacts (Figure 122 - right side)			Net benefits of recycling
		Collection, sorting and reprocessing	Collection and landfill	Primary material production	Total avoided impacts	
Green house gases	t CO <sub>2</sub>	0.47	-0.01	-1.84	-1.85	-1.38
Cumulative energy demand	GJ LHV	6.22	-0.13	-44.90	-45.03	-38.81
Water use	kL H <sub>2</sub> O	6.65	0.00	-70.67	-70.67	-64.02
Solid waste	tonnes	0.27	-0.95	-0.06	-1.01	-0.74

Network diagrams detailing key processes that influence the impact listed in Table 13 are shown in Figure 21 to Figure 23. For further information regarding interpretation of network diagrams, refer to Understanding Network Diagrams (Figure 1).

## Key assumptions

Table 14 describes the key processes and data sources used to determine the benefits and impacts associated with the collection, recycling and reprocessing of 1 tonne of PVC. The table also includes the products and processes avoided when 1 tonne of PVC is recycled.

**Table 14: Inventory for recycling of PVC, kerbside source (1 tonne)**

Item	Flow	Unit	Comment
<b>Recycling process flows (Figure 20 — left hand side)</b>			
Waste collection and transport to MRF	26.8	m <sup>3</sup>	Based on PVC bulk density of 24.4m <sup>3</sup> /tonne plus 2.44m <sup>3</sup> for collection of associated contaminants in recycling which are disposed at MRF. Grant (2001a). Transport model for kerbside collection based on Grant (2001b); refer appendices for discussion on transport. Emission of the truck from NGGIC (1997).
Sorting of PVC at Material Recovery Facility (MRF)	26.8	m <sup>3</sup>	Based on PVC bulk density of 24.4m <sup>3</sup> /tonne plus 2.44m <sup>3</sup> for collection of associated contaminants in recycling which are disposed at MRF. Grant (2001a). Energy inputs from Nishtala (1997) and estimated from equipment specifications.
Baling of PVC	0.90	tonne	Estimated 10 per cent loss at MRF Electricity inputs from Nishtala (1997), 12kWh per tonne.
Transport to reprocessor	20	km	For consistency with the assumption made for C&I and C&D waste, 20km is used as a default value for transport. Refer appendices for discussion on transport. Emissions from transport based on a trucking model from Apelbaum (2001)

Item	Flow	Unit	Comment
Reprocessing PVC into secondary material	0.9	tonne	PVC reprocessing based on PVC input. Data based on a specific company process (Grant and James 2005). Figures cannot be displayed for confidentiality issues. 15 per cent loss during reprocessing, so reprocessing 0.9 tonne of PVC waste ends up with 0.765 tonne of reprocessed PVC output.
Transport of waste from sorting to landfill	20	km	Emissions from transport based on an articulated truck, 28 tonne load on 30 tonne truck. Trucking model developed from data provided by Apelbaum (2001)
Treatment of waste in landfill	0.1	tonne	10 per cent assumed reject rate at MRF. Operation to the landfill from a personal communication with S. Middleton, Pacific Waste, NSW, 1998 Emissions factors from Nielson (1998)
<b>Avoided process flows (Figure 20 – right hand side)</b>			
Collection and transport of waste to landfill	26.8	m <sup>3</sup>	Waste collection avoided by sending material to MRF above. Transport model for kerbside collection based on Grant (2001b); refer appendices for discussion on transport. Emission of the truck from Apelbaum (2001), NGGIC (1997) and other sources.
Treatment of waste PVC in landfill	1	tonne	Operation to the landfill from a personal communication with S. Middleton, Pacific Waste, NSW, 1998 Emissions factors from Nielson (1998)
Primary production of PVC	0.765	tonne	For 0.9 tonne reprocessed, 0.765 tonne of secondary PVC is produce, thereby avoiding 0.765 tonne of virgin PVC production. PVC production updated from Packaging Waste project (Grant 2001) with input from Australian Vinyls and Boustead (1997)

### Data Quality

Table 15 presents a summary of the data quality for the main processes considered. It shows the data sources used; if they are general data or specific to a company; the age of the data; the geographic location that the data were based on; and, the nature of the technology considered.

**Table 15: Data quality for life cycle inventory data modelled for recycling and landfilling of PVC, kerbside source (1 tonne)**

	Primary data source	Geography	Data Age	Technology	Representativeness
Recycling collection and transport	NGGIC 1997, Apelbaum 2001	Australia	2001	Average	Average from all suppliers
Transportation distances	Estimate	Sydney	2009	Average	Estimate based on simple radial transport model
Reprocessing PVC	Grant & James (2005), Boustead (1997)	Australia	1997–2000	Average technology	Mixed data
Avoided virgin PVC production	Boustead (1997), Australian Vinyls (1999)	Australia	1997–1999	Average technology	Data from a specific process and company
Avoided landfill impacts	Tellus Packaging Study, 1992	Australia	1995–1999	Unspecified	Mixed data

## B) C&I and C&D collection system

### *Processes considered*

In the case of the C&I and C&D collection system, it has been assumed that segregated waste collected is sent directly to the reprocessing site without any sorting process, or associated losses. The model developed takes into account transportation impacts incurred to bring the material from C&I and C&D sources to the material reprocessing facility.

Once at the reprocessing facility, the model considers the impacts of material reprocessing required to convert the waste material into secondary PVC. Losses associated with this process are included in the analysis. The model also illustrates the processes considered in determining the impact of the processes avoided when recycling PVC from C&I and C&D sources. Three main processes are considered, the collection of PVC waste and landfill treatment, and the primary manufacture of PVC from virgin resources. The system is also described in Figure 20 (processes unique to C&I,C&D collection have been shaded accordingly).

### *Results*

Considering both the recycling process flows and the avoided process flows, described in Figure 20, an inventory of environmental flows was developed. This inventory was then assessed using the Australian Impact Assessment Method, with results described in Table 16.

**Table 16: Benefits and impacts of recycling PVC from C&I and C&D sources (per tonne)**

Impact category	Unit	<u>Recycling process impacts</u> (Figure 122 - left side)	<u>Avoided process impacts</u> (Figure 122 - right side)			<u>Net benefits of recycling</u>
		Collection, sorting and reprocessing	Collection and landfill	Primary material production	Total avoided impacts	
Green house gases	t CO <sub>2</sub>	0.10	-0.01	-2.05	-2.06	-1.95
Cumulative energy demand	GJ LHV	1.10	-0.13	-49.89	-50.02	-48.92
Water use	kL H <sub>2</sub> O	7.27	0.00	-78.52	-78.52	-71.25
Solid waste	tonnes	0.17	-0.95	-0.07	-1.02	-0.84

Network diagrams detailing key processes that influence the impact listed in Table 16 are shown in Figure 25 to Figure 28. For further information regarding interpretation of network diagrams, refer to Understanding Network Diagrams (Figure 1).

### *Key assumptions*

Table 17 describes the key processes and data sources used to determine the benefits and impacts associated with the collection, recycling and reprocessing of 1 tonne of PVC. The table also includes the products and processes avoided when 1 tonne of PVC is recycled.

**Table 17: Inventory for recycling of PVC, C&I, C&D sources (1 tonne)**

Item	Flow	Unit	Comment
<b>Recycling process flows (Figure 20 — left hand side)</b>			
Waste collection and transport to reprocessor	20	km	20km distance estimate based on a simplified transport analysis for Sydney. Refer appendices for discussion on transport. Emissions from transport based on a trucking model developed by the Centre for Design, incorporating trucking data from Apelbaum (2001) and other sources. Truck backhaul ratio assumed to be 1.2.
Reprocessing PVC into secondary material	1	tonne	PVC reprocessing based on PVC input. Data based on a specific company process (Grant and James 2005). Figures cannot be displayed for confidentiality issues. 15 per cent loss during reprocessing, so reprocessing 1 tonne of PVC waste ends up with 0.85 tonne of reprocessed PVC output
<b>Avoided process flows (Figure 20 — right hand side)</b>			
Collection and transport of waste to landfill	20	km	20km distance estimate based on a simplified transport analysis for Sydney, refer appendices for discussion on transport. Emissions from transport based on a trucking model developed by the Centre for Design, incorporating trucking data from Apelbaum (2001), Truck backhaul ratio assumed to be 1:2.
Treatment of waste in landfill	1	tonne	Operation to the landfill from a personal communication with S. Middleton, Pacific Waste, NSW, 1998 Emissions factors from Nielson (1998)
Primary production of PVC	0.85	tonne	For 1 tonne reprocessed, 0.85 tonne of secondary PVC is produce, thereby avoiding 0.85 tonne of virgin PVC production. PVC production updated from Packaging Waste project (Grant 2001) with input from Australian Vinyls and Boustead (1997)

### Data Quality

Table 18 presents a summary of the data quality for the main processes considered. It shows the data sources used; if they are general data or specific to a company; the age of the data; the geographic location that the data were based on; and, the nature of the technology considered.

**Table 18: Data quality for life cycle inventory data modelled for recycling and landfilling of PVC, kerbside source (1 tonne)**

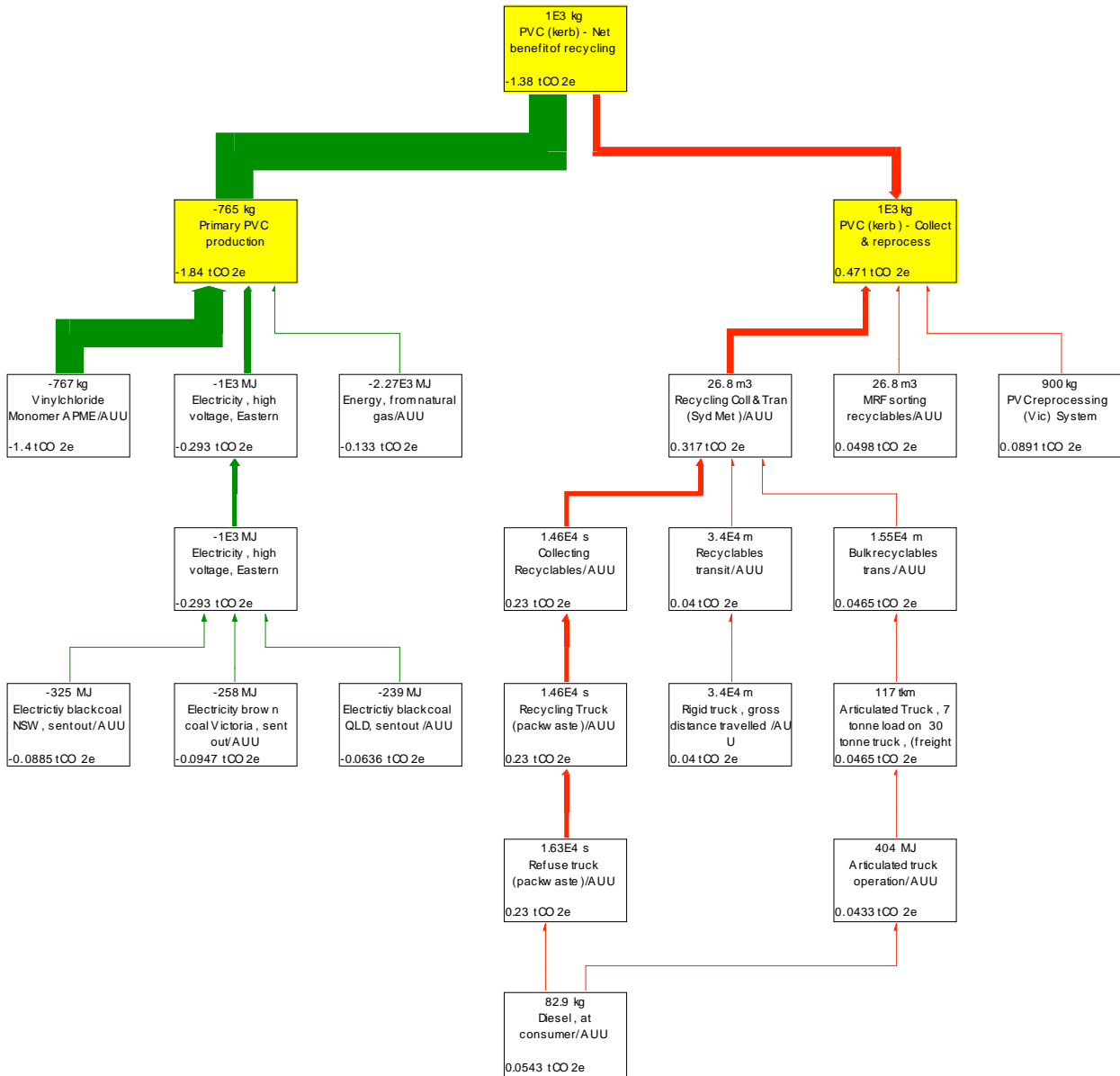
	Primary data source	Geography	Data Age	Technology	Representativeness
Recycling collection and transport	Apelbaum 2001	Australia	2001	Average	Average from all suppliers
Transportation distances	Estimate	Sydney	2009	Average	Estimate based on simple radial transport model
Reprocessing PVC	Grant & James (2005), Boustead (1997)	Australia	1997–2000	Average technology	Mixed data
Avoided virgin PVC production	Boustead (1997), Australian Vinyls (1999)	Australia	1997–1999	Average technology	Data from a specific process and company
Avoided landfill impacts	Tellus Packaging Study, 1992	Australia	1999–1999	Unspecified	Mixed data

## References

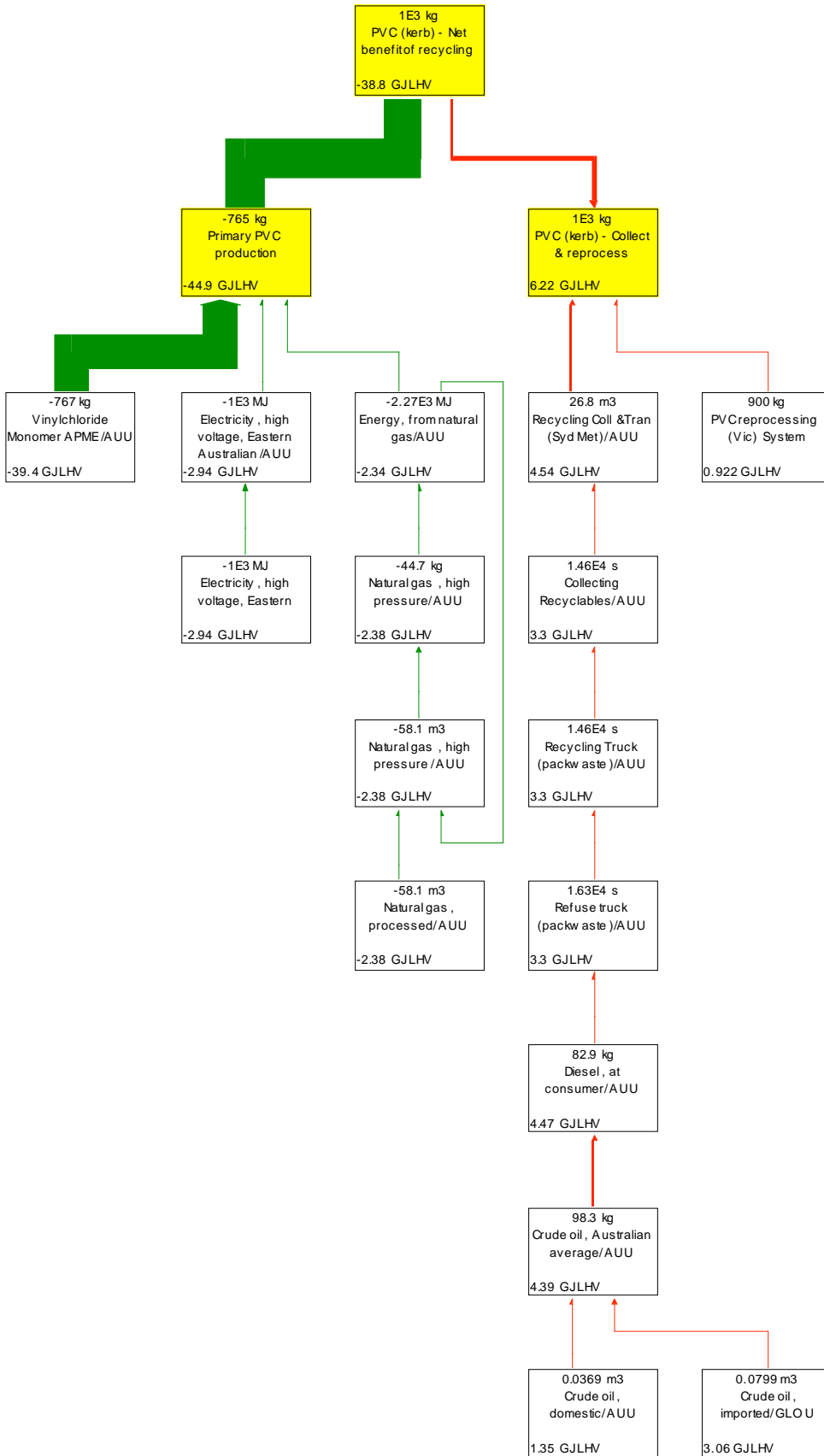
- Apelbaum Consulting Group (2001), Australian Transport facts 2001 Tables in Excel Format, Blackburn, Victoria.
- Australian Vinyls (1999), Environmental Report on PVC, Australian Vinyls.
- Boustead I. (1997), Eco-profile of PVC production in Australia, Boustead Consulting Ltd.
- Cryogrind (2000), personal communication between Basil Signaki (cryogrind) and Karli James (VU)
- DEH (2004), National Pollutant Inventory Data for year 2002, Department of Environment, Canberra.
- John Scheirs (2003), End-of-life Environmental Issued with PVC in Australia, ExcelPlas Polymer Technology (EPT)
- Grant and James (2005), Life Cycle Impact Data for resource recovery from C&I and C&D waste in Victoria final report, Melbourne, Victoria, Centre for Design at RMIT university ([www.cfd.rmit.edu.au](http://www.cfd.rmit.edu.au))
- Grant, T., James, K., Lundie, S., Sonneveld, K., (2001a), Life Cycle Assessment for Paper and Packaging Waste Management Scenarios in Victoria, EcoRecycle, Melbourne
- Grant, T., James, K.L., Lundie, S., Sonneveld, K., Beavis, P. (2001b), Report for Life Cycle Assessment for Paper and Packaging Waste Management Scenarios in New South Wales, NSW Environment Protection Authority, Sydney
- IVAM 4.0 Database (2004), IVAM Environmental Research, Amsterdam, Netherlands, from [www.ivam.nl/index.php?id=164&L=1](http://www.ivam.nl/index.php?id=164&L=1)
- National Greenhouse Gas Inventory (2002 through 2006), Department of Climate Change, Canberra
- Nielson, P., Hauschild, M., (1998): Product Emissions from Municipal Solid Waste Landfills. Part 1: Landfill Model. Int J LCA 3 (3) 158–168, Landsberg
- Swiss Centre for Life Cycle Inventories. (2004). "EcoInvent Database version 1.01." from <http://www.ecoinvent.ch/en/index.htm>.
- Tellus Institute (1992), Tellus Packaging Study, for the Council of State Governments, US EPA and New Jersey Department of Environmental Protection and Energy
- Wang, F. (1996). Solid Waste Integrated Management Model. PhD Thesis in the Department of Chemical and Metallurgical Engineering. Melbourne, RMIT.

## Network diagrams — Kerbside collection

Figure 21: Recycling process network diagram — Green house gases indicator. Processes contributing less than 2 per cent to total are not shown. Major processes from results table above are shown shaded.

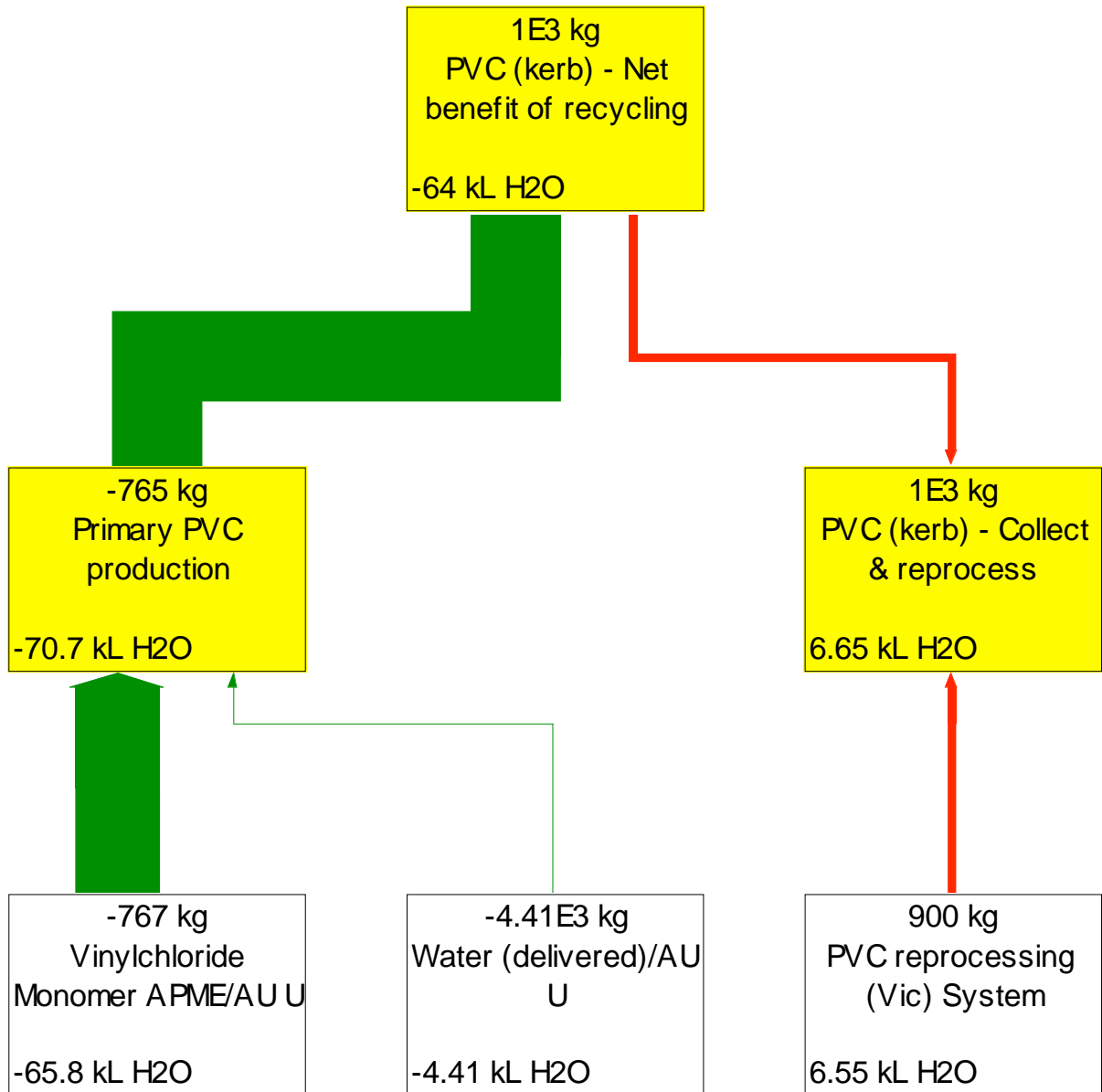


**Figure 22: Recycling process network diagram — Cumulative energy demand indicator. Processes contributing less than 2 per cent to total are not shown. Major processes from results table above are shown shaded.**

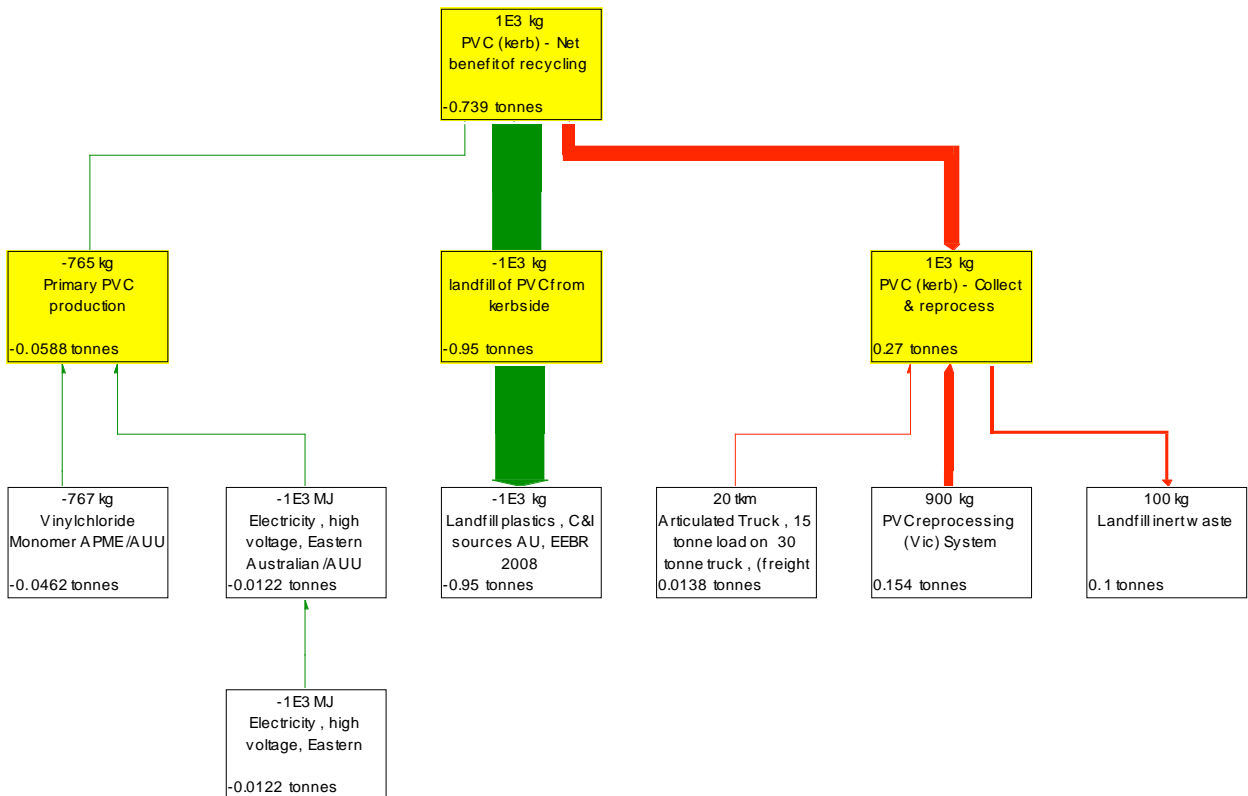




**Figure 23: Recycling process network diagram — Water indicator. Processes contributing less than 1 per cent to total are not shown. Major processes from results table above are shown shaded.**

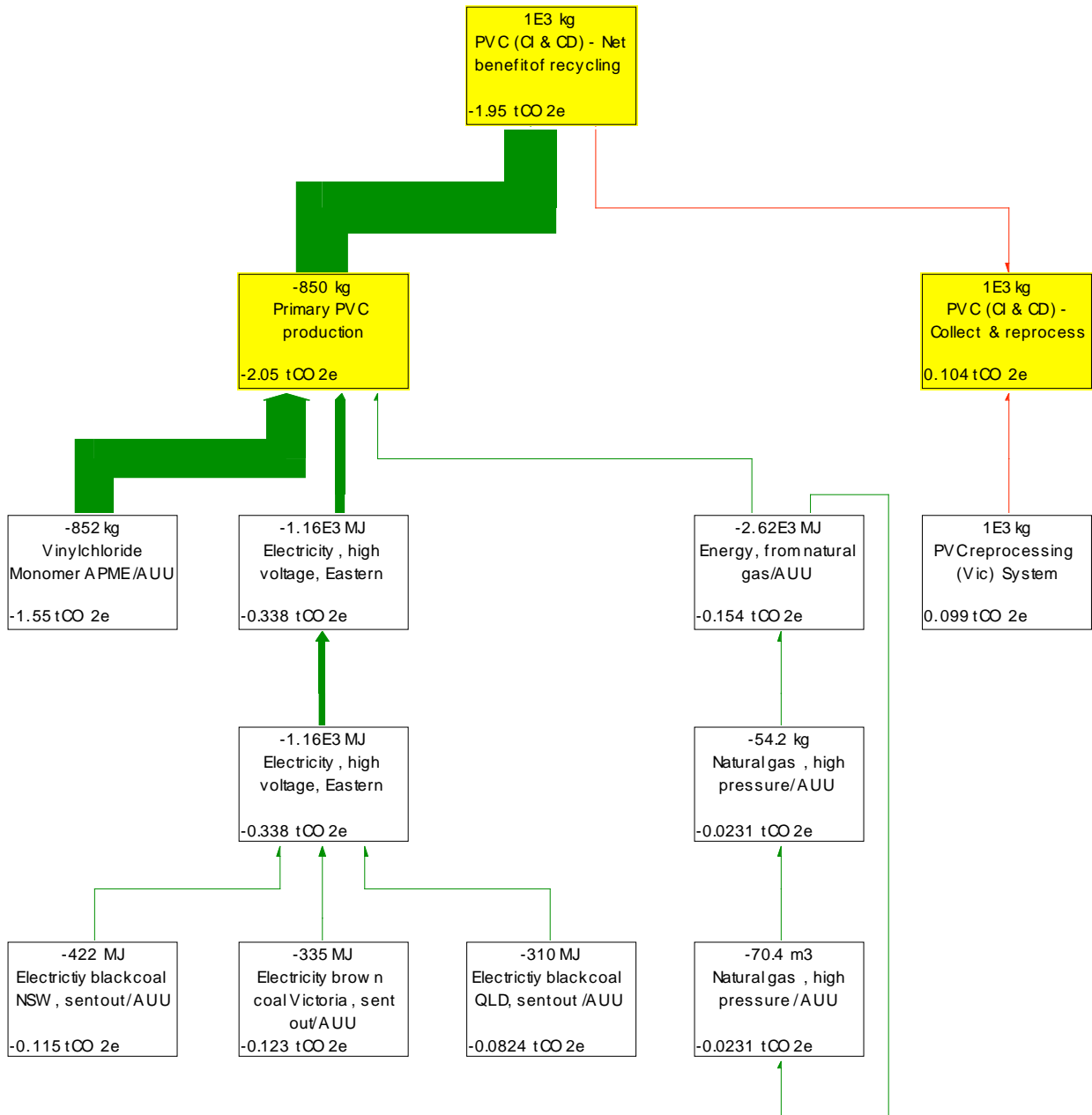


**Figure 24: Recycling process network diagram — Solid waste indicator. Processes contributing less than 1 per cent to total are not shown. Major processes from results table above are shown shaded.**

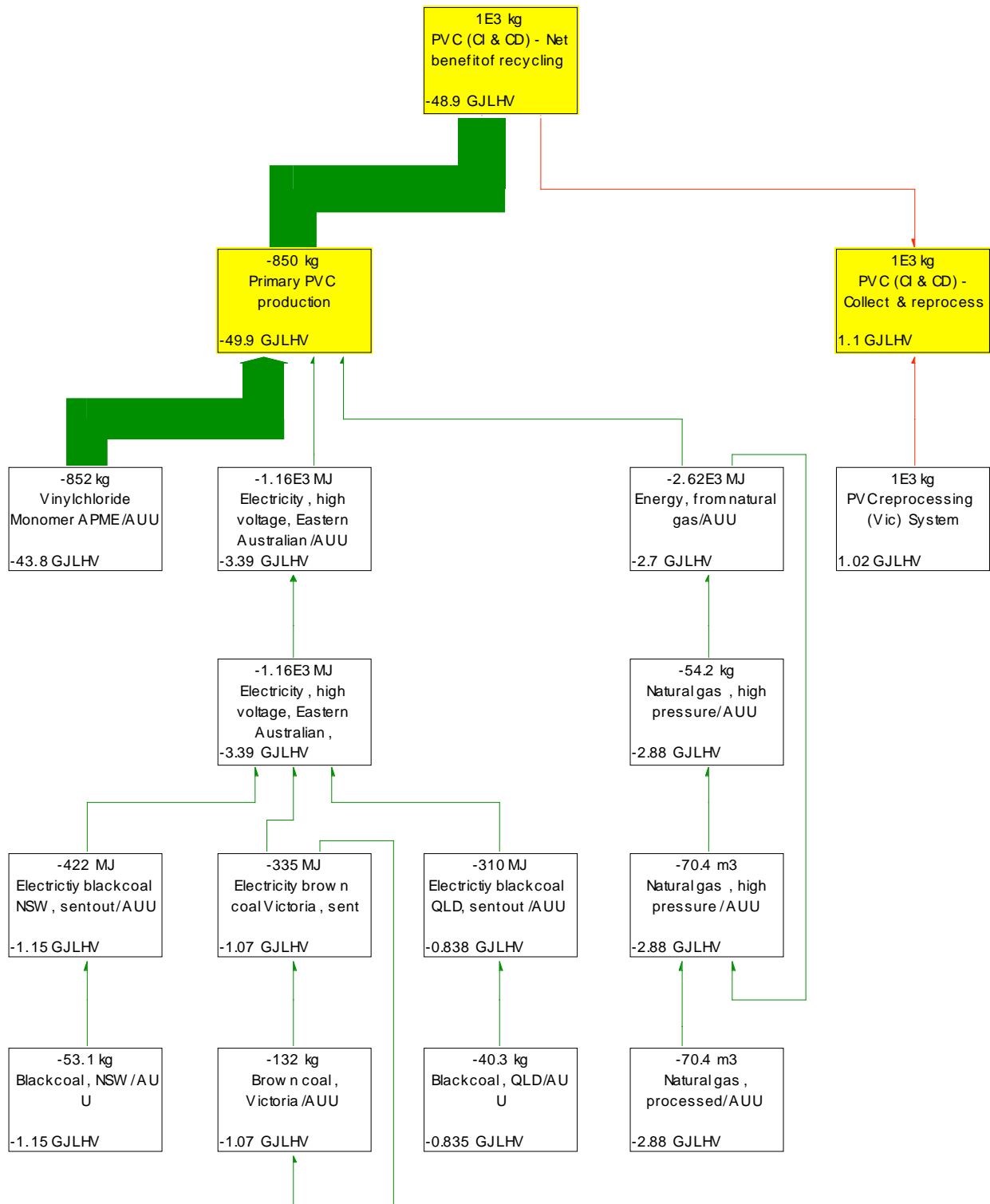


## Network diagrams — C&I and C&D collection

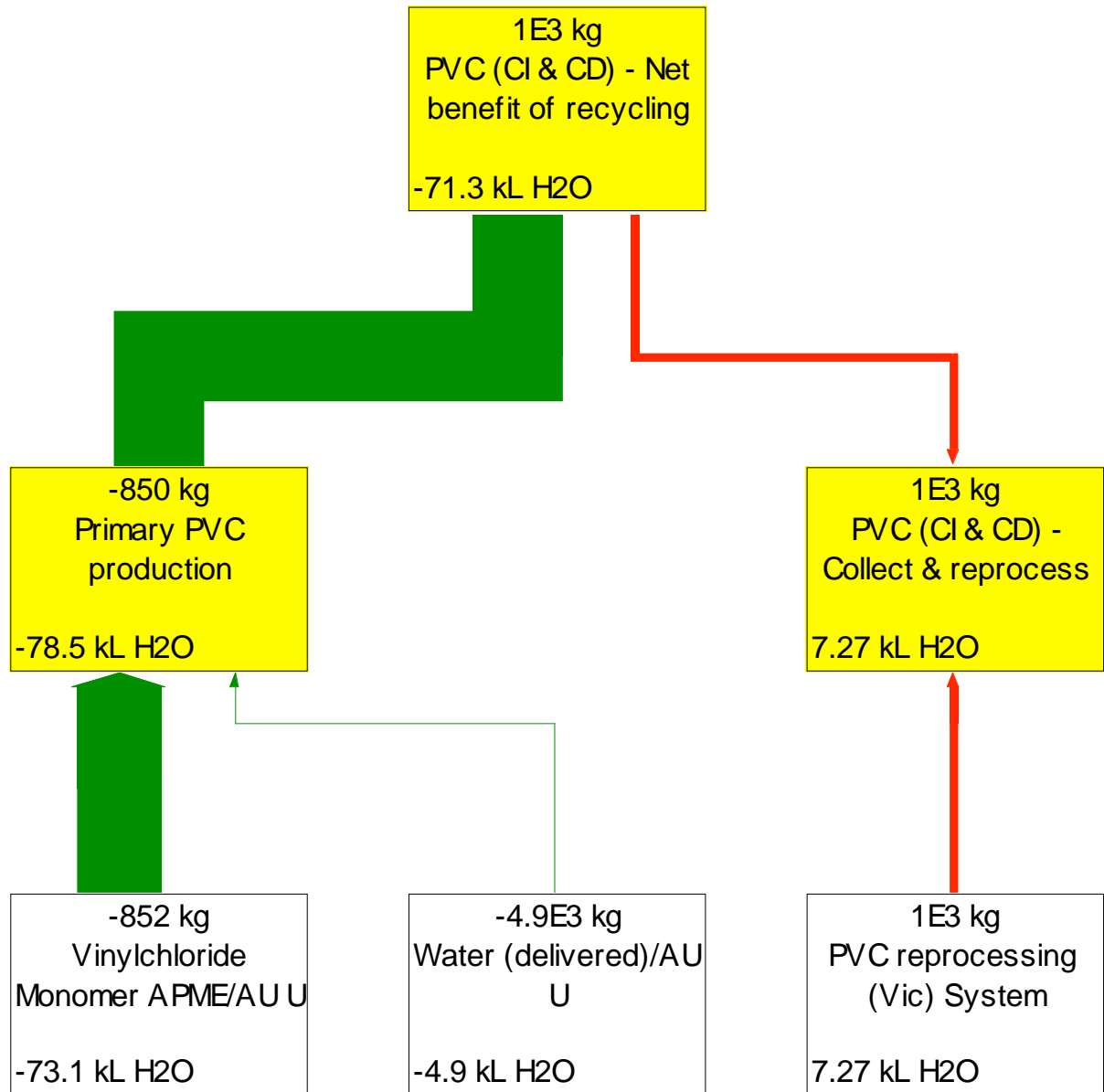
Figure 25: Recycling process network diagram — Green house gases indicator. Processes contributing less than 1 per cent to total are not shown. Major processes from results table above are shown shaded.



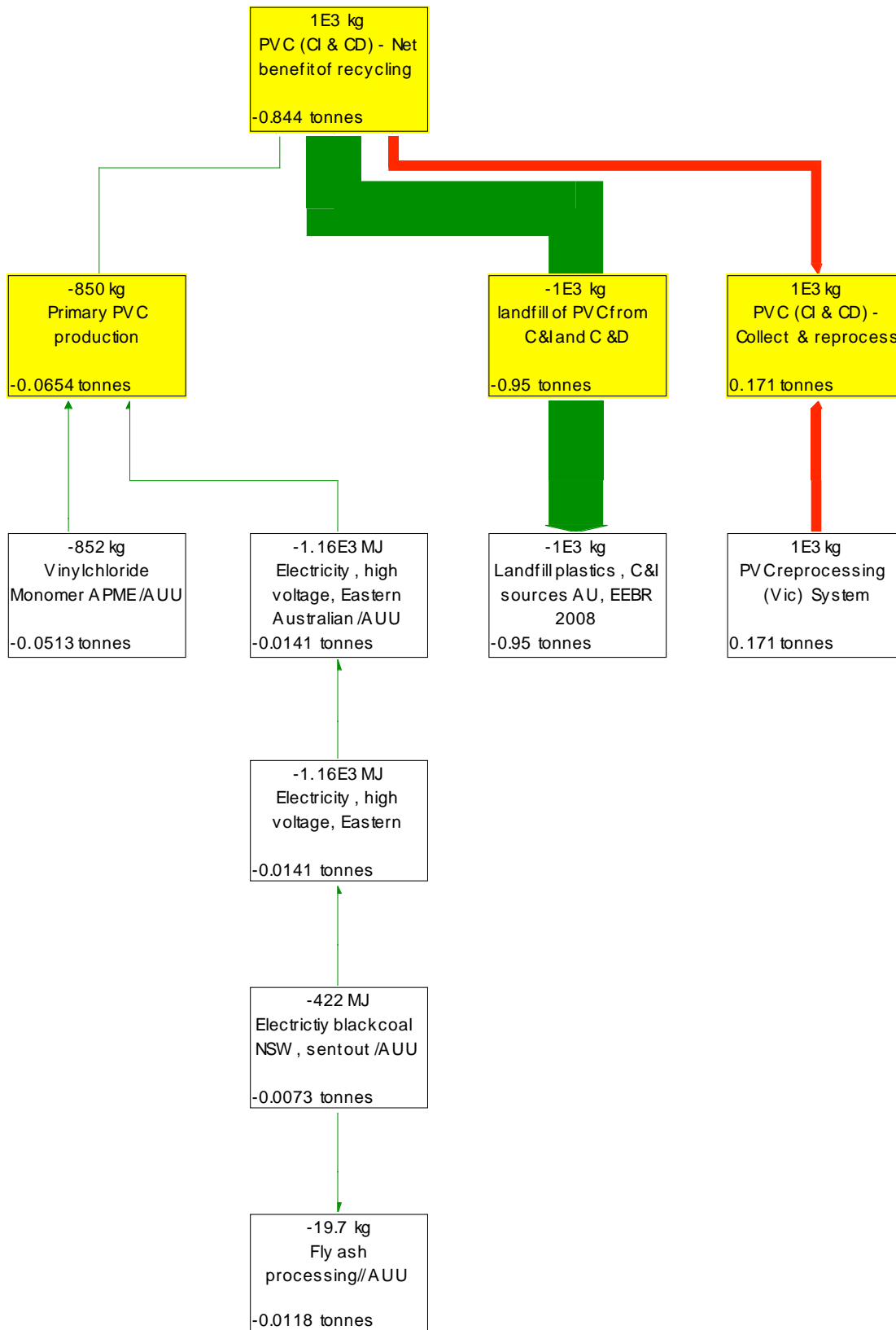
**Figure 26: Recycling process network diagram — Cumulative energy demand indicator. Processes contributing less than 1 per cent to total are not shown. Major processes from results table above are shown shaded.**



**Figure 27: Recycling process network diagram — Water indicator. Processes contributing less than 1 per cent to total are not shown. Major processes from results table above are shown shaded.**



**Figure 28: Recycling process network diagram — Solid waste indicator. Processes contributing less than 1 per cent to total are not shown. Major processes from results table above are shown shaded.**



## Mixed plastics

### *Process description*

The mixed plastics category addresses the plastics that are either:

- i) not from the other categories addressed specifically (PVC, PP, HDPE, etc); or,
- ii) in a form that doesn't allow segregated recycling. Materials like plasticised PVC, laminate films, expanded polystyrene, would be grouped in that category along with other materials.

This summary should be considered as a rough estimate of impacts associated with the offshore reprocessing of plastic materials that either cannot be reprocessed locally, or that cannot be adequately segregated to allow local reprocessing to occur. Mixed plastics are assumed to be sent to China for reprocessing back into low grade polymers, like polypropylene. At the offshore reprocessing facility, the material is shredded, screened for contaminants (such as metals), washed and ground into granulate.

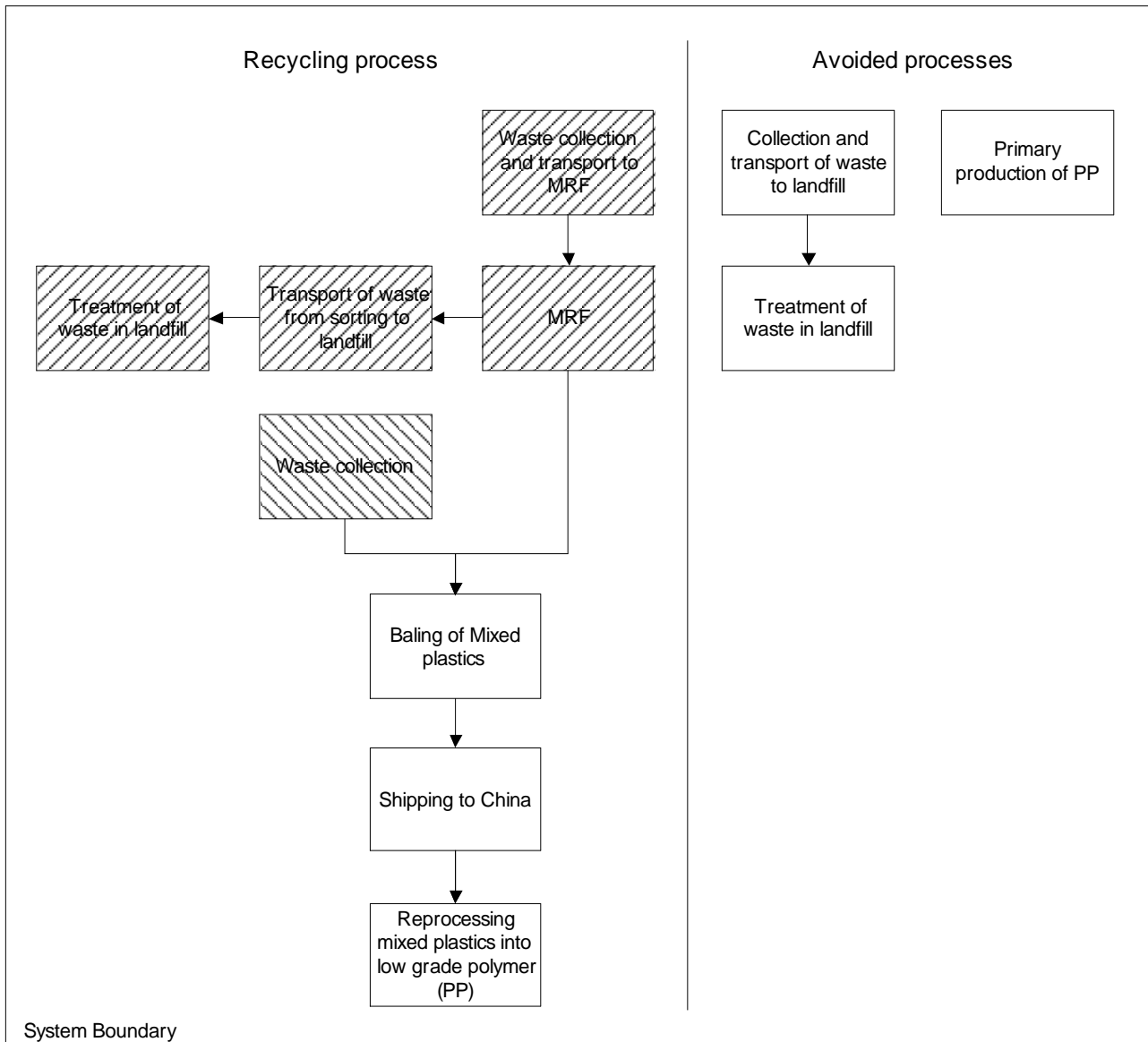
#### **Two collection systems for waste mixed plastics were considered in the model:**



- A) Kerbside collection — municipal collection of mixed plastics in commingled from households, and processing through a Materials Recovery Facility.
- B) C&I, C&D collection — the segregated waste collected is sent directly to the reprocessing site without any sorting process, or associated losses.

The unique nature of each collection system drives differences in the impacts associated with mixed plastics recycling. For this reason the mixed plastics recycling processes considered and impacts generated have been described separately in the following sections, according to the collection method used.

Figure 29 illustrates the processes considered in determining the overall impact of mixed plastics recycling from kerbside and C&I and C&D sources (shown to the left of the vertical line), and the processes considered in determining the overall impact of the avoided processes (shown to the right of the vertical line).

**Figure 29: Processes considered in determining the net impacts of the recycling process from kerbside and C&I and C&D sources.**



-  Modelled for Kerbside sources only
-  Modelled for CI&CD sources only

## A) Kerbside collection system

### *Processes considered*

The kerbside collection system involves collection of waste for recycling from the kerbside and transport to a Materials Recovery Facility (MRF) which sorts the commingled materials in the recycling stream. The model developed takes into account transportation impacts as well as sorting impacts incurred to bring the material from the kerbside to the material reprocessing facility. During sorting, waste material is generated and transported to landfill.

Once at the reprocessing facility, the model considers the impacts of material reprocessing required to convert the waste material into low grade polymer. Losses associated with this process



are included in the analysis. The kerbside treatment system is illustrated in Figure 29 (unique processes shaded accordingly).

In order to determine the net benefit of recycling a material it is necessary to consider the processes avoided when recycling is undertaken. Figure 29 also illustrates the processes that would be avoided if mixed plastics wastes were to be recycled (shown to the right of the vertical line). Two main avoided processes are considered; the collection and disposal to landfill of mixed plastics wastes from the kerbside, and the primary manufacture of PP from virgin resources.

Polypropylene (PP) is used to represent the avoided product. Applications for recycled mixed plastic are varied and could potentially displace many kinds of plastic material. For the purposes of this study PP was selected as a typical substitute in line with Grant and James (2005).

## Results

Considering both the recycling process flows and the avoided process flows, described in Figure 29, an inventory of environmental flows was developed. This inventory was then assessed using the Australian Impact Assessment Method, with results described in Table 19.

**Table 19: Benefits and impacts of recycling mixed plastics from kerbside sources (per tonne). Benefits are shown negative, impacts are shown positive.**

Impact category	Unit	Recycling process impacts (Figure 131 - left side)	Avoided process impacts (Figure 131 - right side)			Net benefits of recycling
		Collection, sorting and reprocessing	Collection and landfill	Primary material production	Total avoided impacts	
Green house gases	t CO <sub>2</sub>	0.70	-0.19	-2.05	-2.24	-1.53
Cumulative energy demand	GJ LHV	9.54	-2.72	-65.06	-67.78	-58.24
Water use	kL H <sub>2</sub> O	12.53	-0.02	-1.14	-1.16	11.37
Solid waste	tonnes	0.14	-0.95	-0.02	-0.97	-0.83

Network diagrams detailing key processes that influence the impact listed in Table 19 are shown in Figure 30 to Figure 33. For further information regarding interpretation of network diagrams, refer to Understanding Network Diagrams (Figure 1).

## Key assumptions

Table 20 describes the key processes and data sources used to determine the benefits and impacts associated with the collection, recycling and reprocessing of 1 tonne of mixed plastic. The table also includes the products and processes avoided when 1 tonne of mixed plastic is recycled.

**Table 20: Inventory for recycling mixed plastics (1 tonne)**

Item	Flow	Unit	Comment
<b>Recycling process flows (Figure 29 — left hand side)</b>			
Waste collection and transport to MRF	18.96	m <sup>3</sup>	17.23 m <sup>3</sup> per tonne + 1.72 m <sup>3</sup> for carrying 10 per cent non recyclables as contamination in collection, from Grant (2001) Transport model for kerbside collection based on Grant (2001), refer discussion below Emission of the truck from NGGIC (1997)
Sorting at Material Recovery Facility (MRF)	18.96	m <sup>3</sup>	10 per cent non recyclables as contamination in collection; density of the material in cubic meter from Grant (2001) Energy inputs from Nishtala (1997) and estimated from equipment specifications
Baling of mixed plastics	0.9	tonne	Assumption of 10 per cent loss after MRF (Grant, 2001) Electricity inputs from Nishtala (1997), 12kWh per tonne.
Shipping to China	20,000	km	Assumption that waste are sent to China for reprocessing by ship and then come back to Sydney (10,000km assumed for a one way trip). Fuel use data are from Apelbaum (1997). Greenhouse related emissions are based on fuel use with factors taken from NGGIC (1997). Non greenhouse emissions apart from lead are taken from Delft (1996).
Reprocessing mixed plastics into low grade polymer (PP)	0.9	tonne	10 per cent loss after MRF. Data supplied by Visy Plastics aggregated with data from Buwal 250. 10 per cent assumed lost at reprocessing, so process ends up with 0.81 tonne reprocessed low grade polymer output.
Transport of waste from sorting to landfill	20	km	Emissions from transport based on an articulated truck, 28 tonne load on 30 tonne truck. Trucking model developed from data provided by Apelbaum (2001)
Treatment of waste in landfill.	100	kg	Loss from MRF and Visy Plastic factory sorting process. Emission factors for total plastics from Tellus (1992). Operation to the landfill from a personal communication with S. Middleton, Pacific Waste, NSW, 1998
<b>Avoided process flows (Figure 19 — right hand side)</b>			
Collection and transport of waste to landfill	18.96	m <sup>3</sup>	Waste collection avoided by sending material to MRF above. Transport model for kerbside collection based on Grant (2001b); refer appendices for discussion on transport. Emission of the truck from Apelbaum (2001), NGGIC (1997) and other sources.
Treatment of waste in landfill	1	tonne	Emission factors for total plastics from Tellus (1992). Operation to the landfill from a personal communication with S. Middleton, Pacific Waste, NSW, 1998
Primary production of polypropylene	0.81	tonne	Polypropylene (PP) data is used to represent the avoided product. Applications for mixed plastic recyclate are varied and could potentially displace many kinds of plastic material. For the purposes of this study PP was selected as a typical substitute in line with Grant and James (2005). Reprocessing ends up with 0.81 tonne of reprocessed low grade polymer thereby avoiding 0.81 tonne of virgin PP production. PP production impacts adapted for Australian conditions from the IVAM database.

### *Data quality table and comment*

Table 21 presents a summary of the data quality for the main processes considered. It shows the data sources used; if they are general data or specific to a company; the age of the data; the geographic location that the data were based on; and, the nature of the technology considered.

**Table 21: Data quality for life cycle inventory data modelled for recycling and landfilling of mixed plastics, kerbside source**

	Primary data source	Geography	Data Age	Technology	Representativeness
Impacts of transportation modes	EcolInvent, NGGI, Apelbaum (1997) and Delft	European data adapted to Australian conditions and Australian data	1997–2005	Average technology	Mixed data
Reprocessing of mixed plastics	Visy Plastics, Idemat	Australia and European data	2004–2008	Average technology	Data from a reprocessor mixed with average data
Avoided materials production	IVAM	Australia	1998	Modern technology	Average of all suppliers
Avoided landfill impacts	Tellus Institute	Australia	1999	Unspecified	Mixed Data

## **B) C&I and C&D collection system**

### *Processes considered*

In the case of the C&I and C&D collection system, it has been assumed that mixed plastic waste collected is sent directly to the reprocessing site without any sorting process, or associated losses. The model developed takes into account transportation impacts incurred to bring the material from C&I and C&D sources to the material reprocessing facility.

Once at the reprocessing facility, the model considers the impacts of material reprocessing required to convert the waste material into low grade polymer. Losses associated with this process are included in the analysis. The model also illustrates the processes considered in determining the impact of the processes avoided when recycling mixed plastics from C&I and C&D sources. Three main processes are considered, the collection of waste mixed plastics and landfill treatment, and the primary manufacture of PP from virgin resources. The system is also described in Figure 29 (unique processes shaded accordingly).

### *Results*

Considering both the recycling process flows and the avoided process flows, described in Figure 29, an inventory of environmental flows was developed. This inventory was then assessed using the Australian Impact Assessment Method, with results described in Table 22.

**Table 22: Benefits and impacts of recycling mixed plastics from C&I and C&D sources (per tonne). Benefits are shown negative, impacts are shown positive.**

Impact category	Unit	<u>Recycling process impacts</u> (Figure 131 - left side)	<u>Avoided process impacts</u> (Figure 131 - right side)			<u>Net benefits of recycling</u>
		Collection, sorting and reprocessing	Collection and landfill	Primary material production	Total avoided impacts	
Green house gases	t CO <sub>2</sub>	0.69	-0.01	-2.27	-2.28	-1.59
Cumulative energy demand	GJ LHV	9.44	-0.13	-72.29	-72.43	-62.99
Water use	kL H <sub>2</sub> O	12.52	0.00	-1.26	-1.27	11.25
Solid waste	tonnes	0.14	-0.95	-0.02	-0.97	-0.83

Network diagrams detailing key processes that influence the impact listed in Table 22 are shown in Figure 34 to Figure 37. For further information regarding interpretation of network diagrams, refer to Understanding Network Diagrams (Figure 1).

### Key assumptions

Table 23 describes the key processes and data sources used to determine the benefits and impacts associated with the collection, recycling and reprocessing of 1 tonne of mixed plastic. The table also includes the products and processes avoided when 1 tonne of mixed plastic is recycled.

**Table 23: Inventory for recycling mixed plastics (1 tonne)**

Item	Flow	Unit	Comment
<b>Recycling process flows (Figure 29 — left hand side)</b>			
Waste collection	20	km	20km distance estimate based on a simplified transport analysis for Sydney. Refer transport discussion below. Emissions from transport based on a trucking model adapted from Ecolnvent and NGGI (2004), Truck backhaul ratio assumed to be 1:2.
Baling of mixed plastics	1	tonne	Electricity inputs from Nishtala (1997), 12kWh per tonne.
Shipping to China	20,000	km	Assumption that waste are sent to China for reprocessing by ship and then come back to Sydney (10,000km assumed for a one way trip). Fuel use data are from Apelbaum (1997). Greenhouse related emissions are based on fuel use with factors taken from NGGIC (1997). Non greenhouse emissions apart from lead are taken from Delft (1996).
Reprocessing mixed plastics into low grade polymer (PP)	1	tonne	Reprocessing of polypropylene used as a proxy of the reprocessing of mixed plastics. Data based on process at Visy plastics, supplemented by Idemat (1996). 10 per cent assumed lost at reprocessing, so process ends up with 0.9 tonne reprocessed low grade polymer output.
<b>Avoided process flows (Figure 29 — right hand side)</b>			
Collection and transport of waste to landfill	20	km	Emissions from transport based on an articulated truck, 28 tonne load on 30 tonne truck. Trucking model developed from data provided by Apelbaum (2001) Refer appendices for transport model description.

Item	Flow	Unit	Comment
Treatment of waste in landfill	1	tonne	Emission factors for total plastics from Tellus (1992). Operation to the landfill from a personal communication with S. Middleton, Pacific Waste, NSW, 1998
Primary production of PP	0.9	tonne	Polypropylene (PP) data is used to represent the avoided product. Applications for mixed plastic recyclate are varied and could potentially displace many kinds of plastic material. For the purposes of this study PP was selected as a typical substitute in line with Grant and James (2005). Reprocessing ends up with 0.9 tonne of reprocessed low grade polymer thereby avoiding 0.9 tonne of virgin PP production. PP production impacts adapted for Australian conditions from the IVAM database.

### Data quality table and comment

Tabel 24 presents a summary of the data quality for the main processes considered. It shows the data sources used; if they are general data or specific to a company; the age of the data; the geographic location that the data were based on; and, the nature of the technology considered.

**Table 24: Data quality for life cycle inventory data modelled for recycling and landfilling of mixed plastics**

	Primary data source	Geography	Data Age	Technology	Representativeness
Impacts of transportation modes	Ecolnvent, NGGI, Apelbaum (1997) and Delft	European data adapted to Australian conditions and Australian data	1997–2005	Average technology	Mixed data
Transportation distances	Estimate	Sydney	2009	Average	Estimate based on simple radial transport model
Reprocessing of mixed plastics	Visy Plastics, Idemat	Australia and European data	2004–2008	Average technology	Data from a reprocessor mixed with average data
Avoided materials production	IVAM	Australia	1998	Modern technology	Average of all suppliers
Avoided landfill impacts	Tellus Institute	Australia	1999	Unspecified	Mixed Data

## References

Apelbaum (1997), Australian Transport Task, Energy consumed and Greenhouse Gas Emissions, Volume A, Summary of findings

Delft University of Technology (2001), Idemat database

Delft University of Technology (1996), data from the Section for Environmental Product Development, Faculty of Industrial Design Engineering, The Netherlands

Electricity Supply Association of Australia (2003), Electricity Australia 2003

Grant, T., James, K., (2005), Life Cycle Impact Data for resource recovery from C&I and C&D waste in Victoria final report, Melbourne, Victoria, Centre for Design at RMIT university ([www.cfd.rmit.edu.au](http://www.cfd.rmit.edu.au))

Grant, T., James, K., Lundie, S., Sonneveld, K., (2001), Life Cycle Assessment for Paper and Packaging Waste Management Scenarios in Victoria, EcoRecycle, Melbourne

IVAM 4.0 Database (2004), IVAM Environmental Research, Amsterdam, Netherlands, from [www.ivam.nl/index.php?id=164&L=1](http://www.ivam.nl/index.php?id=164&L=1)

National Greenhouse Gas Inventory Committee (1997), National Greenhouse Gas Inventory, with methodology supplements, Australian Greenhouse Office.

National Greenhouse Gas Inventory Committee (2004), National Greenhouse Gas Inventory, with methodology supplements, Australian Greenhouse Office.

Nishtala, S., Solano-Mora, E., (1997), Description of the Material Recovery Facilities Process Model: Design, Cost, and Life-Cycle Inventory, Research Triangle Institute and North Carolina State University

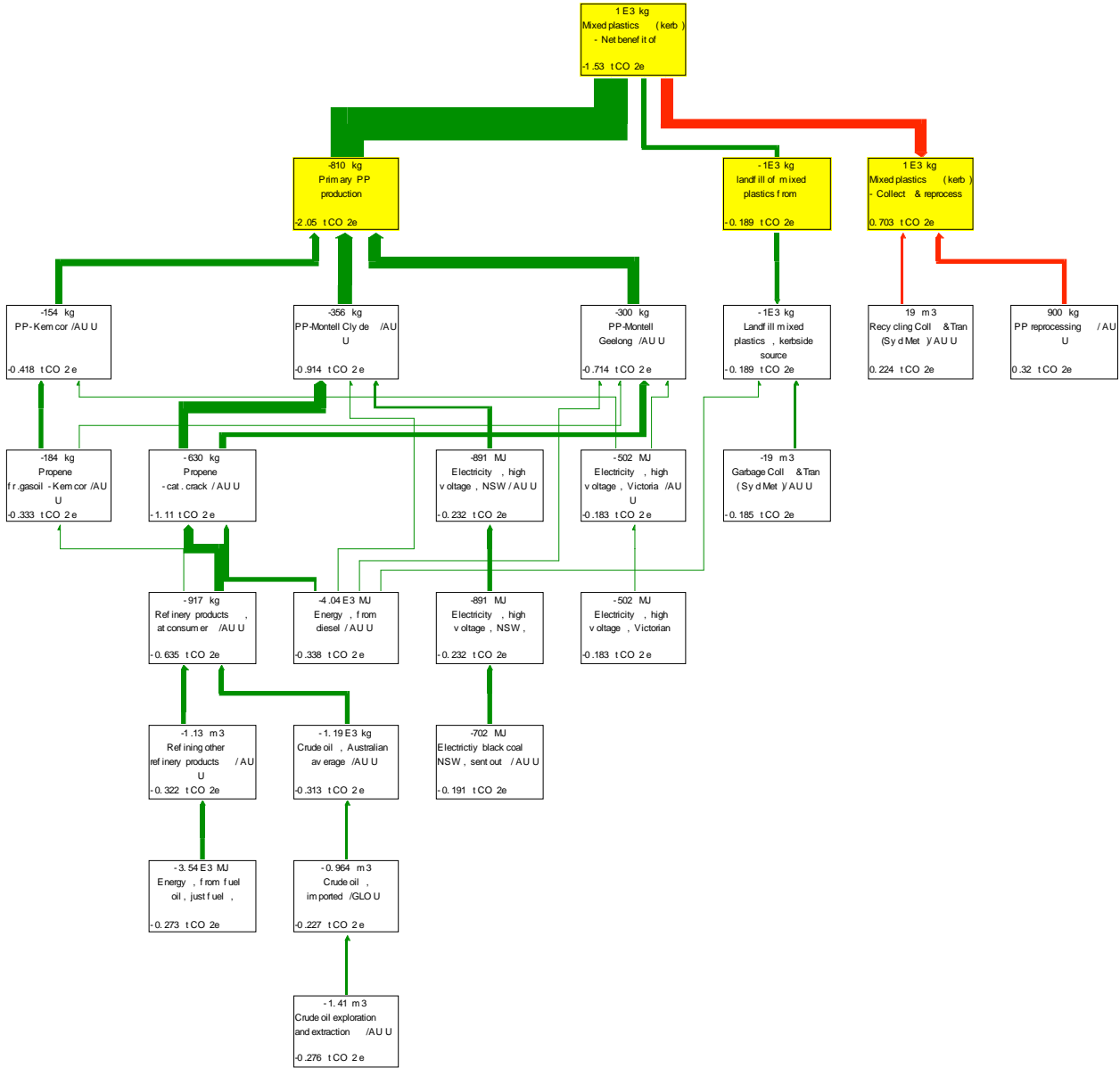
Swiss Centre for Life Cycle Inventories. (2004). "EcoInvent Database version 1.01." from <http://www.ecoinvent.ch/en/index.htm>

Tellus Institute (1992), Tellus Packaging Study, for the Council of State Governments, US EPA and New Jersey Department of Environmental Protection and Energy

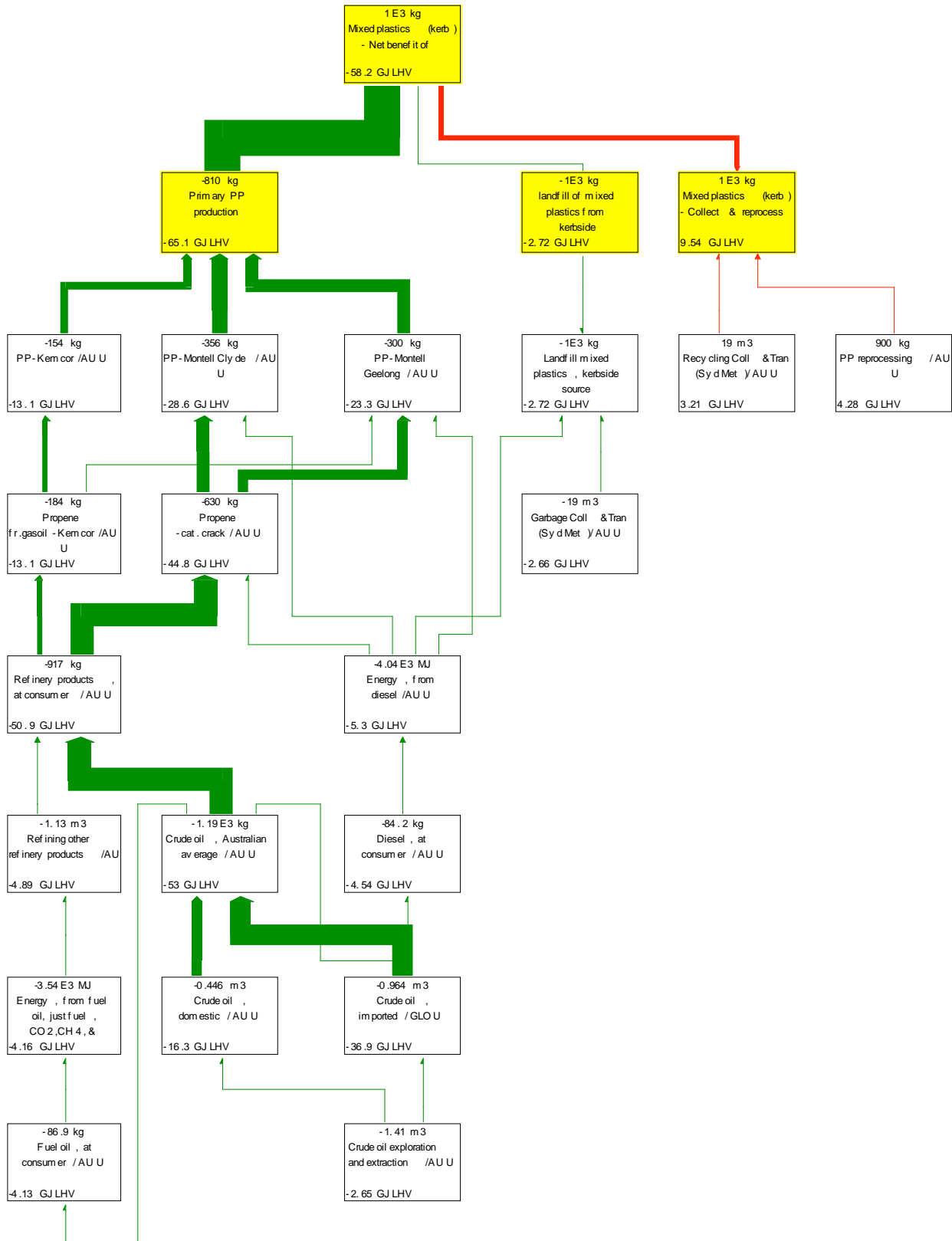
Wang, F. (1996). Solid Waste Integrated Management Model. PhD Thesis in the Department of Chemical and Metallurgical Engineering. Melbourne, RMIT.

## Network diagrams — Kerbside collection

Figure 30: Recycling process network diagram — Green house gases indicator. Processes contributing less than 8 per cent to total are not shown. Major processes from results table above are shown shaded.

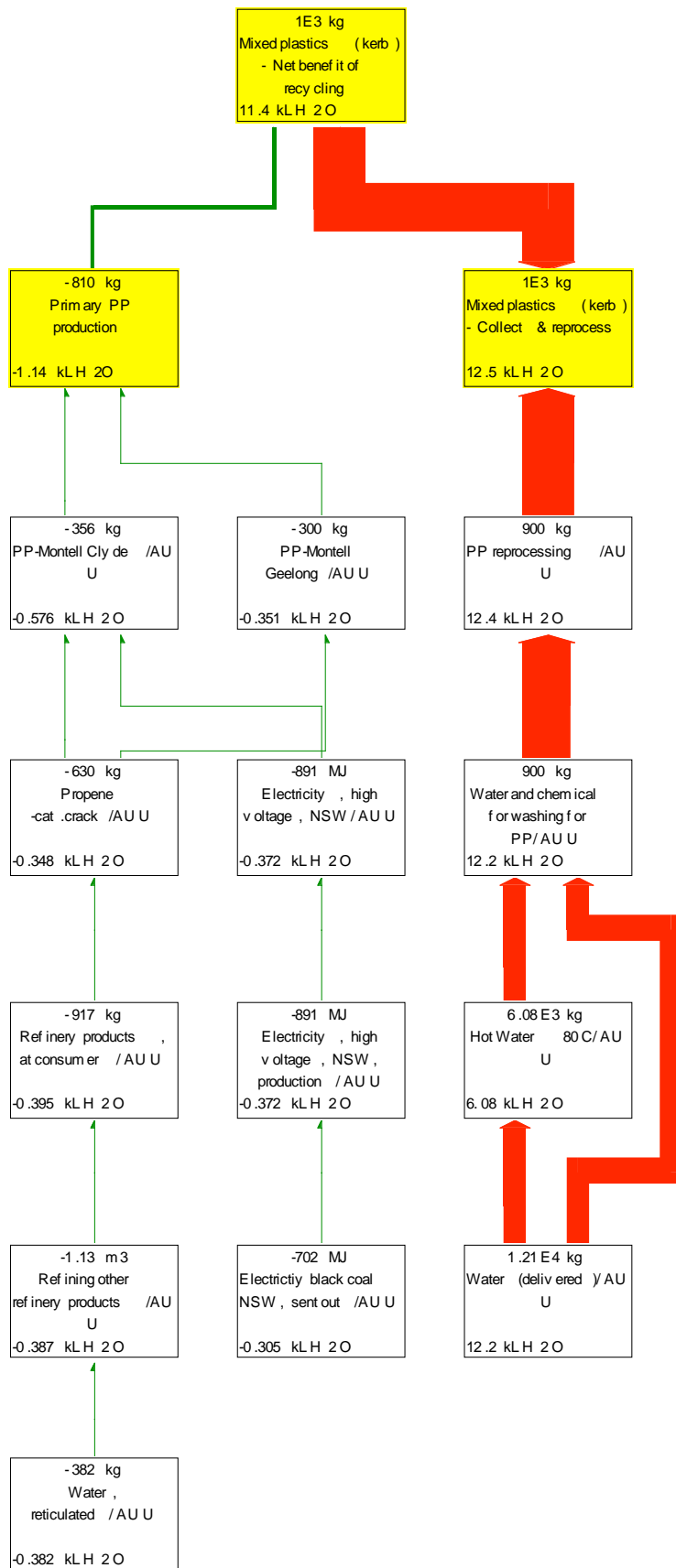


**Figure 31: Recycling process network diagram — Cumulative energy demand indicator. Processes contributing less than 4 per cent to total are not shown. Major processes from results table above are shown shaded.**

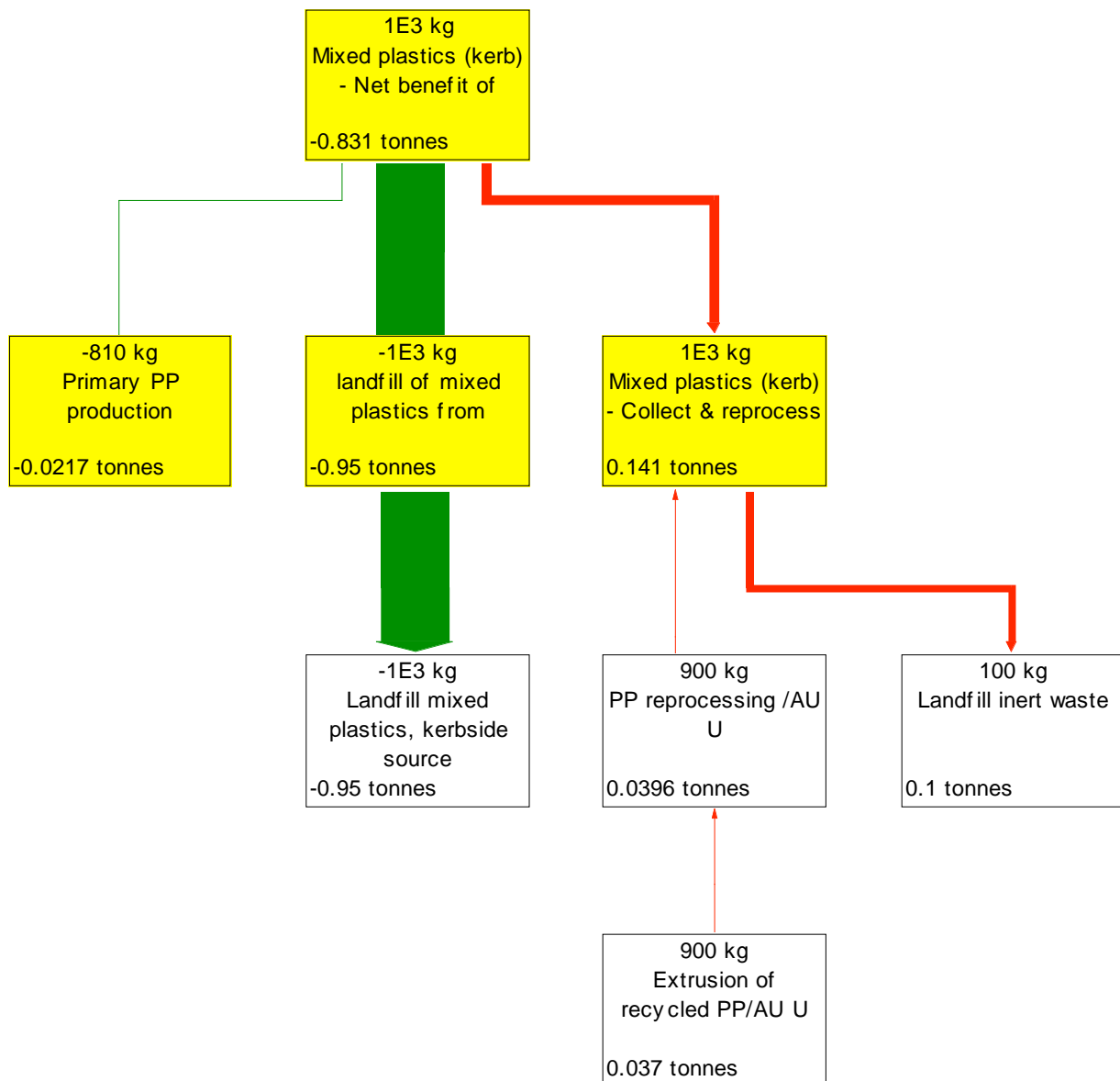




**Figure 32: Recycling process network diagram — Water indicator. Processes contributing less than 2 per cent to total are not shown. Major processes from results table above are shown shaded.**

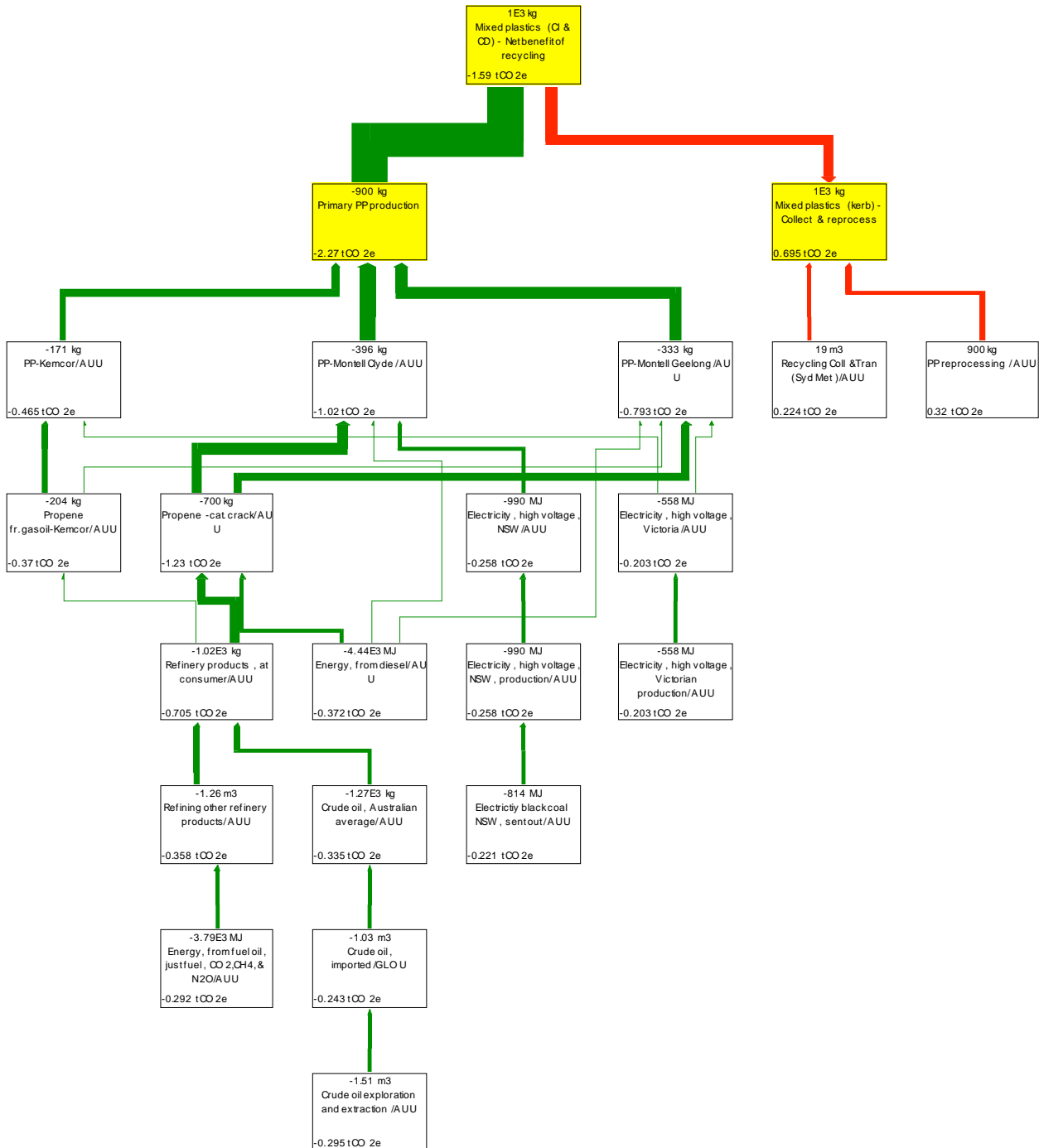


**Figure 33: Recycling process network diagram — Solid waste indicator. Processes contributing less than 2 per cent to total are not shown. Major processes from results table above are shown shaded.**

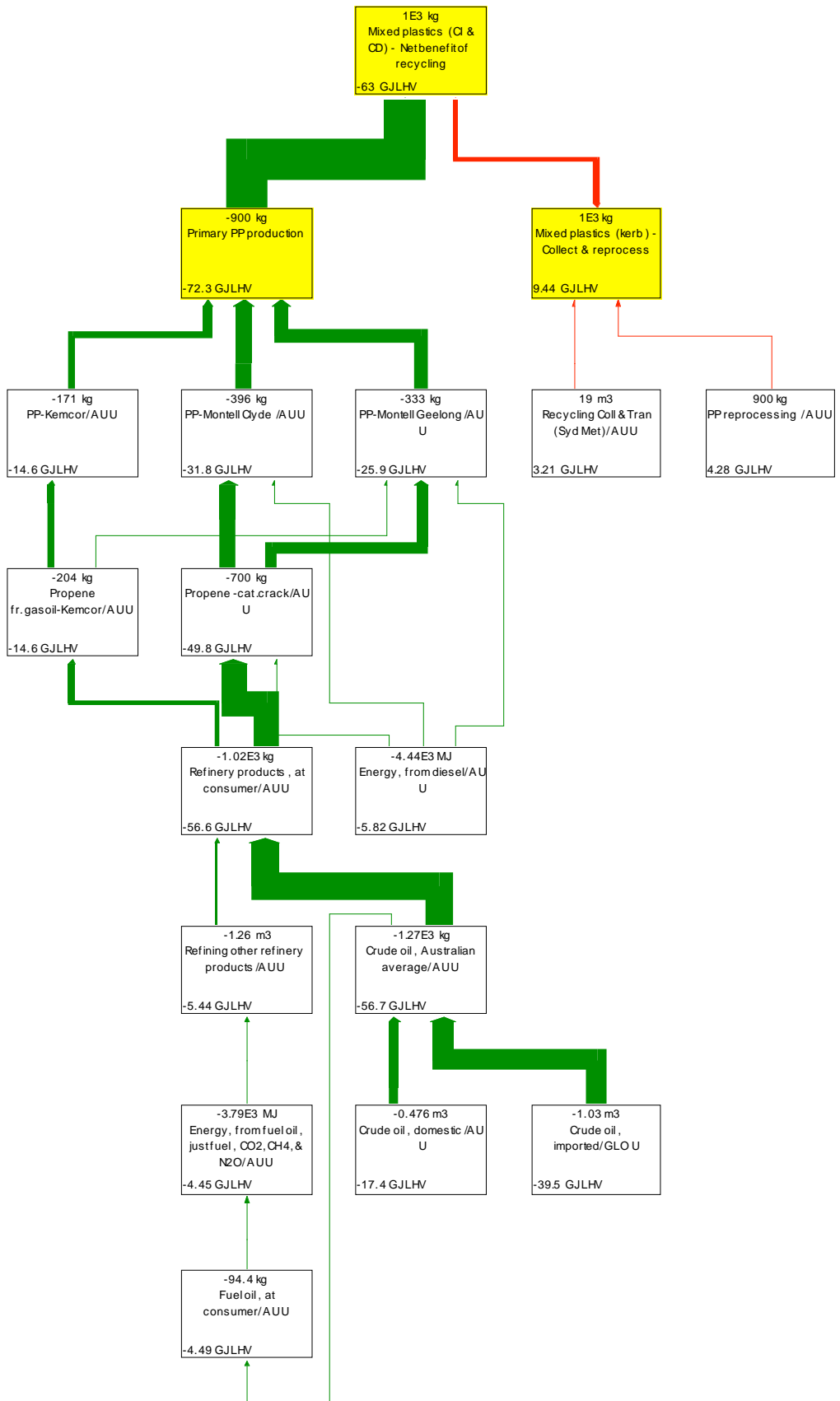


## Network diagrams — C&I and C&D collection

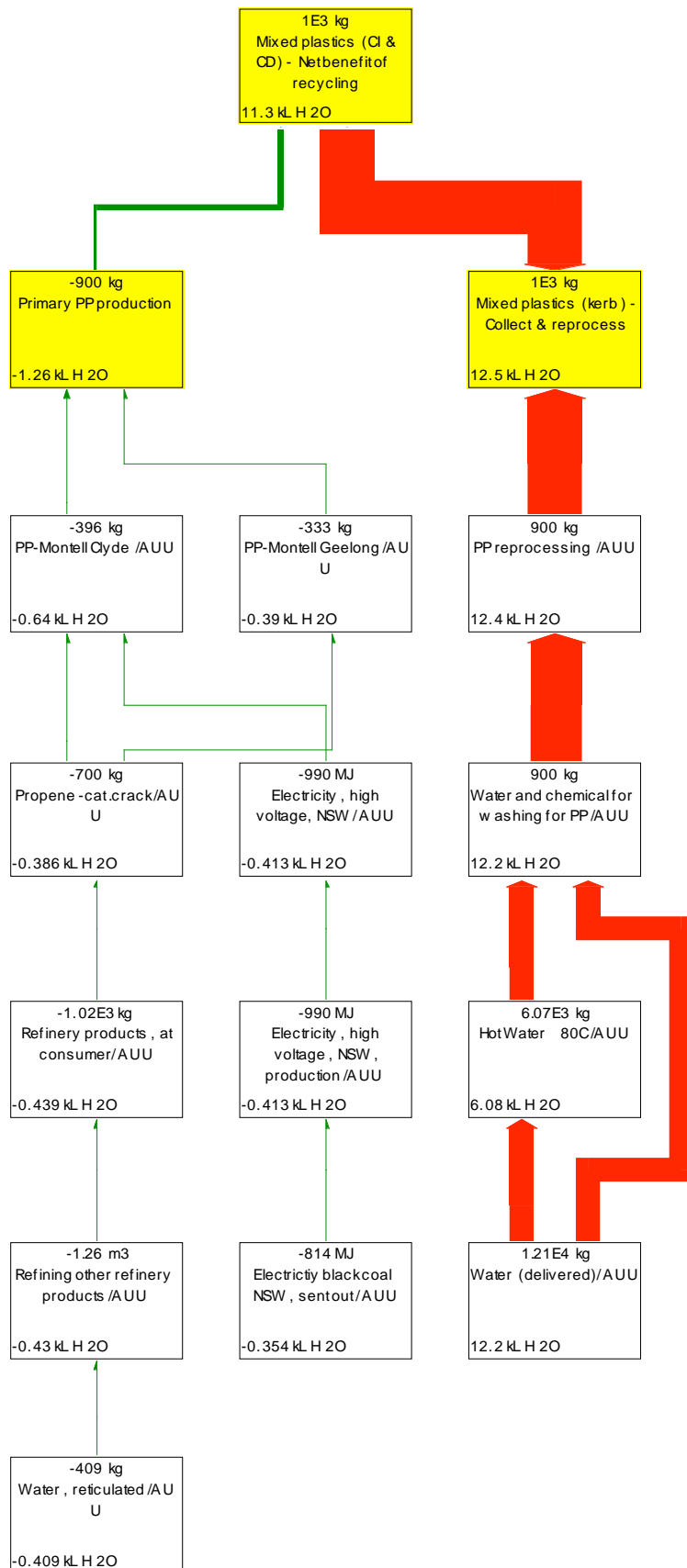
**Figure 34: Recycling process network diagram — Green house gases indicator. Processes contributing less than 8 per cent to total are not shown. Major processes from results table above are shown shaded.**



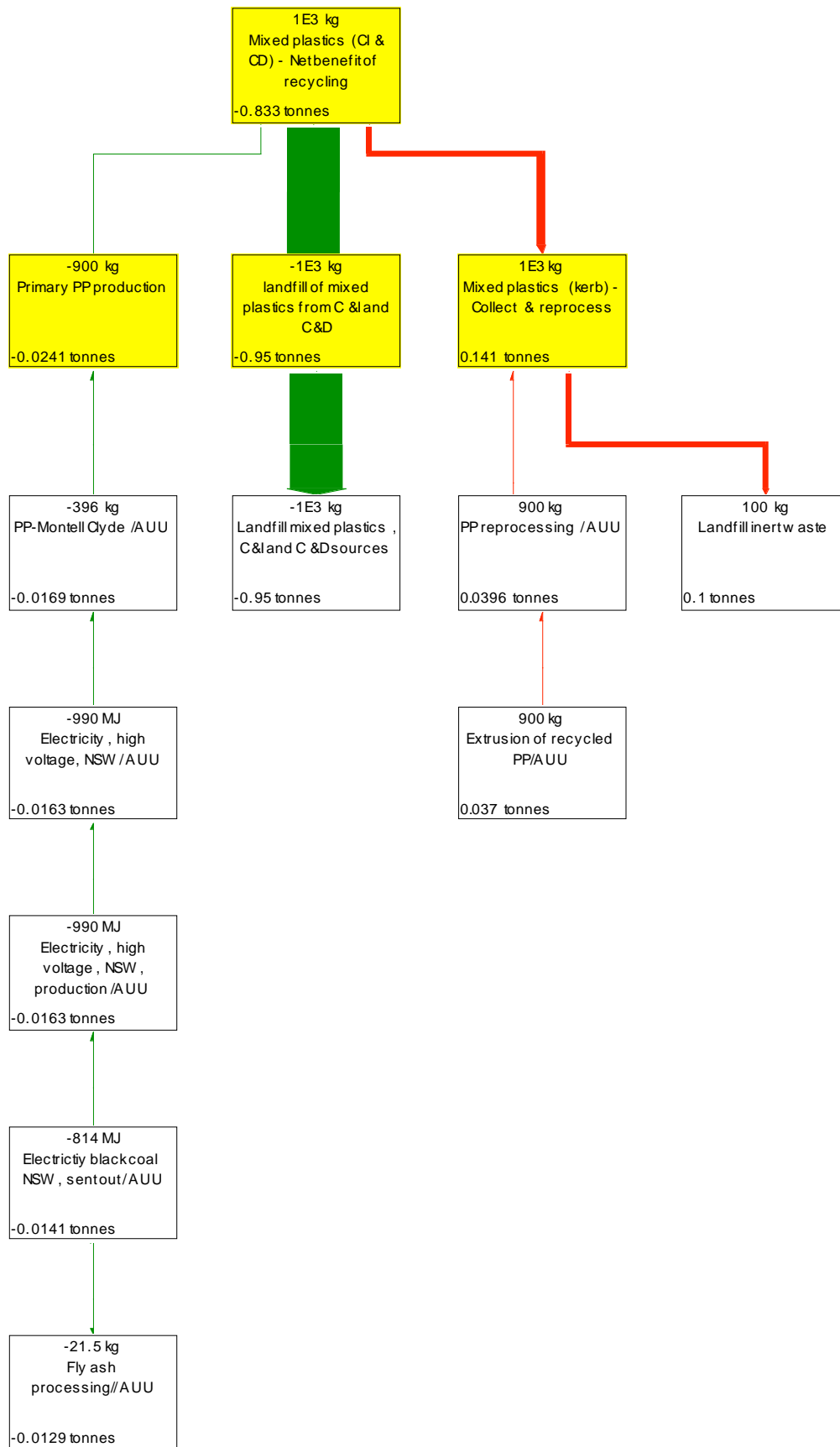
**Figure 35: Recycling process network diagram — Cumulative energy demand indicator. Processes contributing less than 4 per cent to total are not shown. Major processes from results table above are shown shaded.**



**Figure 36: Recycling process network diagram — Water indicator. Processes contributing less than 2 per cent to total are not shown. Major processes from results table above are shown shaded.**



**Figure 37: Recycling process network diagram — Solid waste indicator. Processes contributing less than 1 per cent to total are not shown. Major processes from results table above are shown shaded.**



## Rubber tyres

### *Process Description*

Tyres are collected and sent to various shredding facilities in NSW, Victoria, South Australia and Queensland. There are numerous avenues for tyre disposal including:

- re-use as second hand tyres and retreadable casings
- supply to the cement industry as tyre derived fuel for energy recovery
- shredded and granulated as feedstock material for the production of rubber crumb
- shredded for civil engineering applications
- export where they are used primarily for oil recovery
- applied to landfill as a last resort

Determining the benefits of recycling tyres would ideally involve attempting to quantify each of the above potential uses and recycling processes, however this was considered beyond the scope of this study. Instead a single recycling pathway involving the shredding and granulation to produce rubber crumb was selected and modelled.

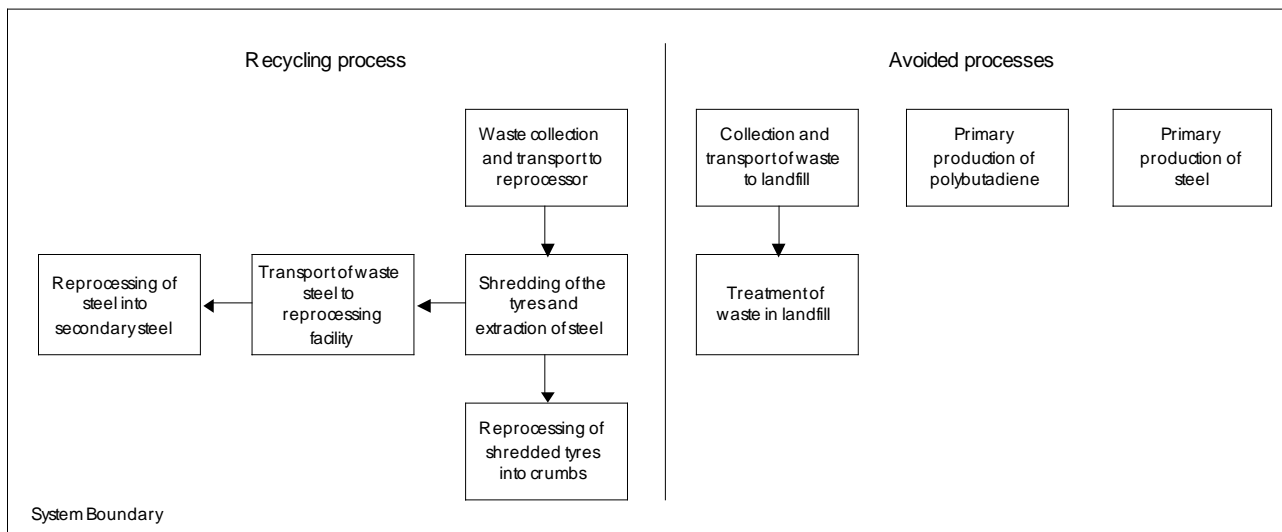
In the process considered, recycling of rubber tyres is undertaken by cutting the tyres, extracting the metal (which is sold to metal recyclers) and then grinding and sieving the rubber to produce a range of crumb and granule sizes which are then sold and used by rubber manufacturers to make rubber products (a substitute for polybutadiene). In 2000, approximately 100,000 tyres were shredded per year prior to landfill treatment (Atech Group, 2001). During the same period 5 millions of tyres were sent to landfill (Atech Group, 2001), which is why we decided not to take the shredding process into account.

#### **Only one collection system for waste tyres was considered in the model:**

C&I, C&D collection — the segregated waste collected is sent directly to the reprocessing site without any further sorting process, or associated losses. The model developed takes into account transportation impacts incurred to bring the material from C&I and C&D sources to the material reprocessing facility. Once at the reprocessing facility, the model considers the impacts of material reprocessing.

Figure 38 illustrates the processes considered in determining the overall impact of rubber tyres recycling from C&I and C&D sources (shown to the left of the vertical line), and the processes considered in determining the impact of the processes avoided when recycling rubber tyres (shown to the right of the vertical line).

**Figure 38: Processes considered in determining the net impacts of the recycling process from C&I and C&D sources.**



### Results

Considering both the recycling process flows and the avoided process flows, described in Figure 38, an inventory of environmental flows was developed. This inventory was then assessed using the Australian Impact Assessment Method, with results described in Table 25.

**Table 25: Benefits and impacts of recycling and avoided landfill of waste tyres from C&I and C&D source (per tonne)**

Impact category	Unit	<u>Recycling process impacts</u> (Figure 140 - left hand side)	<u>Avoided process impacts</u> (Figure 140 - right hand side)			<u>Net benefits of recycling</u>
		Collection and reprocessing	Collection and landfill	Primary material production	Total avoided impacts	
Green house gases	t CO <sub>2</sub>	-0.03	-1.03	-0.01	-1.04	-1.07
Cumulative energy demand	GJ LHV	-0.59	-63.36	-0.13	-63.50	-64.08
Water use	kL H <sub>2</sub> O	0.24	-52.49	0.00	-52.49	-52.25
Solid waste	tonnes	-0.10	-0.03	-0.95	-0.98	-1.07

Network diagrams detailing key processes that influence the impact listed in Figure 38 are shown in Figure 39 to Figure 42. For further information regarding interpretation of network diagrams, refer to Understanding Network Diagrams (Figure 1).

### Key assumptions

Table 26 describes the key processes and data sources used to determine the benefits and impacts associated with the collection, recycling and reprocessing of 1 tonne of tyres. The table also includes the products and processes avoided when 1 tonne of tyres is recycled.



**Table 26: Inventory for recycling waste tyres from C&I and C&D source (1 tonne)**

Item	Flow	Unit	Comment
<b>Process flows (Figure 38 — left hand side)</b>			
Waste collection and transport to reprocessor	20	km	20km distance estimate based on a simplified transport analysis for Sydney; refer appendices for discussion on transport. Emissions from transport based on a trucking model developed by the Centre for Design, incorporating trucking data from Apelbaum (2001), Truck backhaul ratio assumed to be 1:2.
Reprocessing tyres: shredding and crumbing	1	tonne	Assumes that reprocessing 1 tonne of used tyres ends up with 850 kg of rubber crumb. Assumes 10 litres of diesel required to shred and crumb 1 tonne of tyres (based on survey of recyclers). Grant et. al. (2005). 10lx0.850tonnes=8.5
Transport of waste steel to reprocessing facility	20	km	Emissions from transport based on an articulated truck, 28 tonne load on 30 tonne truck. Trucking model developed from data provided by Apelbaum (2001)
Reprocessing of steel into secondary steel	100	kg	Assumption that 10 per cent of tyres is recoverable steel. Recycled steel produces around 5 per cent less usable metal, so reprocessing 100 kg of steel waste ends up with 95 kg of reprocessed steel output. Emission data from the production of steel through electric arc furnace from NPI, input data fom Strezov (2006)
<b>Avoided process (Figure 38 — right hand side)</b>			
Collection and transport of waste to landfill	20	km	20km distance estimate based on a simplified transport analysis for Sydney. Refer transport discussion below. Emissions from transport based on a trucking model developed by the Centre for Design, incorporating trucking data from Apelbaum (2001) and other sources. Truck backhaul ratio assumed to be 1:2.
Treatment of waste in landfill	1	tonne	Emission factors for total plastics from Tellus (1992). Operation to the landfill from a personal communication with S. Middleton, Pacific Waste, NSW, 1998
Primary production of polybutadiene	637	kg	Assumed that 850 kg of crumb replace polybutadiene with 25 per cent less material efficiency (637 kg effectively). Polybutadiene manufacture from a European study by Delft (1996).
Primary production of steel	95	kg	For 100kg reprocessed 95kg of steel is produced thereby avoiding 95kg of virgin steel production. Input data from BHP (2000), and other sources Emission data from NGGIC (1995) and NPI (2002–2003)

### Data Quality

Table 27 describes the key processes and data sources used to determine the benefits and impacts associated with the recycling of 1 tonne of waste tyres from C&I and C&D sources. The table also includes the products and processes avoided when 1 tonne of waste tyres are recycled.

**Table 27: Data quality for life cycle inventory data modelled for recycling and landfilling of waste tyres from C&I and C&D source**

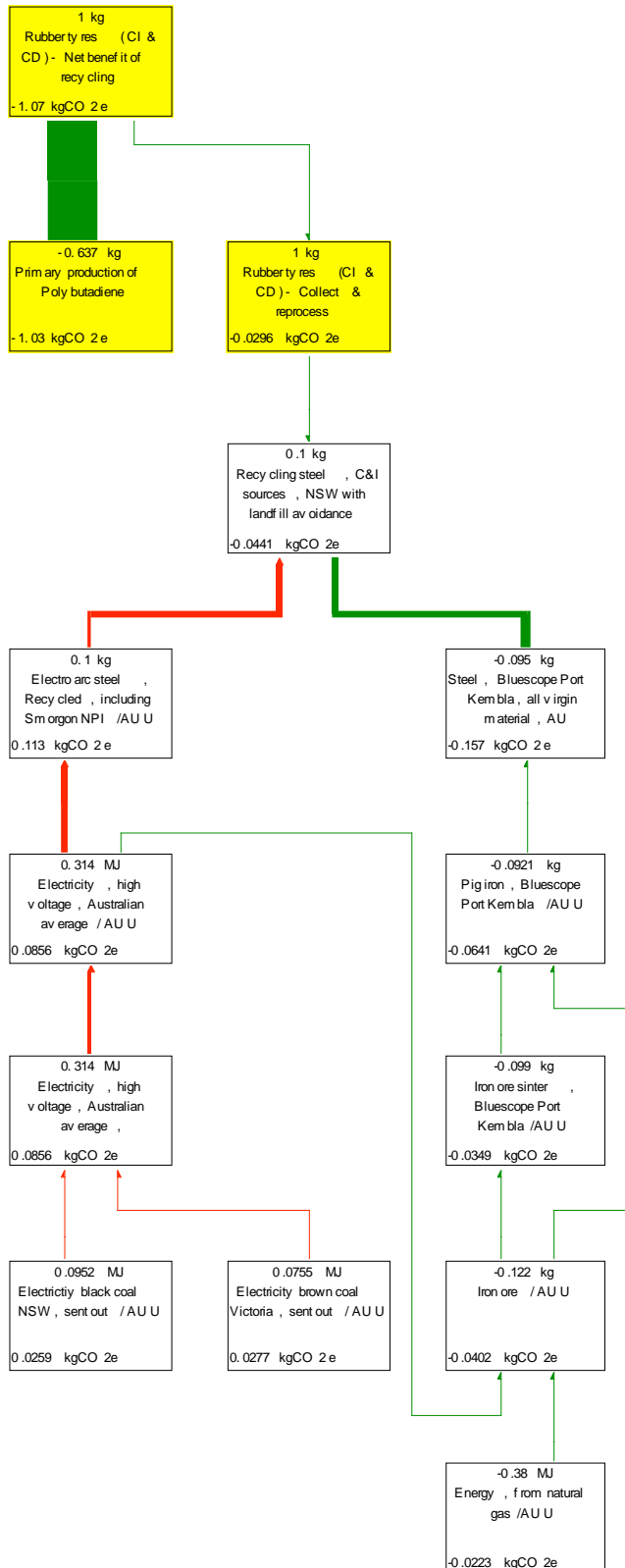
	Primary data source	Geography	Data Age	Technology	Representativeness
Recycling collection and transport	Apelbaum consulting group (2001)	Australia	2001	Average	Average from all suppliers
Transportation distances	Estimate	Sydney	2009	Average	Estimate based on simple radial transport model
Recycling waste tyres	Grant & James (2005)	Australia and European data	2004–2008	Average technology	Data from a reprocessor mixed with average data
Avoided virgin polybutadiene production	Delft (1996)	Unspecified	1995–1999	Modern technology	Average of all suppliers
Avoided landfill impacts	Tellus Packaging Study, 1992	Australia	1995–1999	Unspecified	Mixed Data

## References

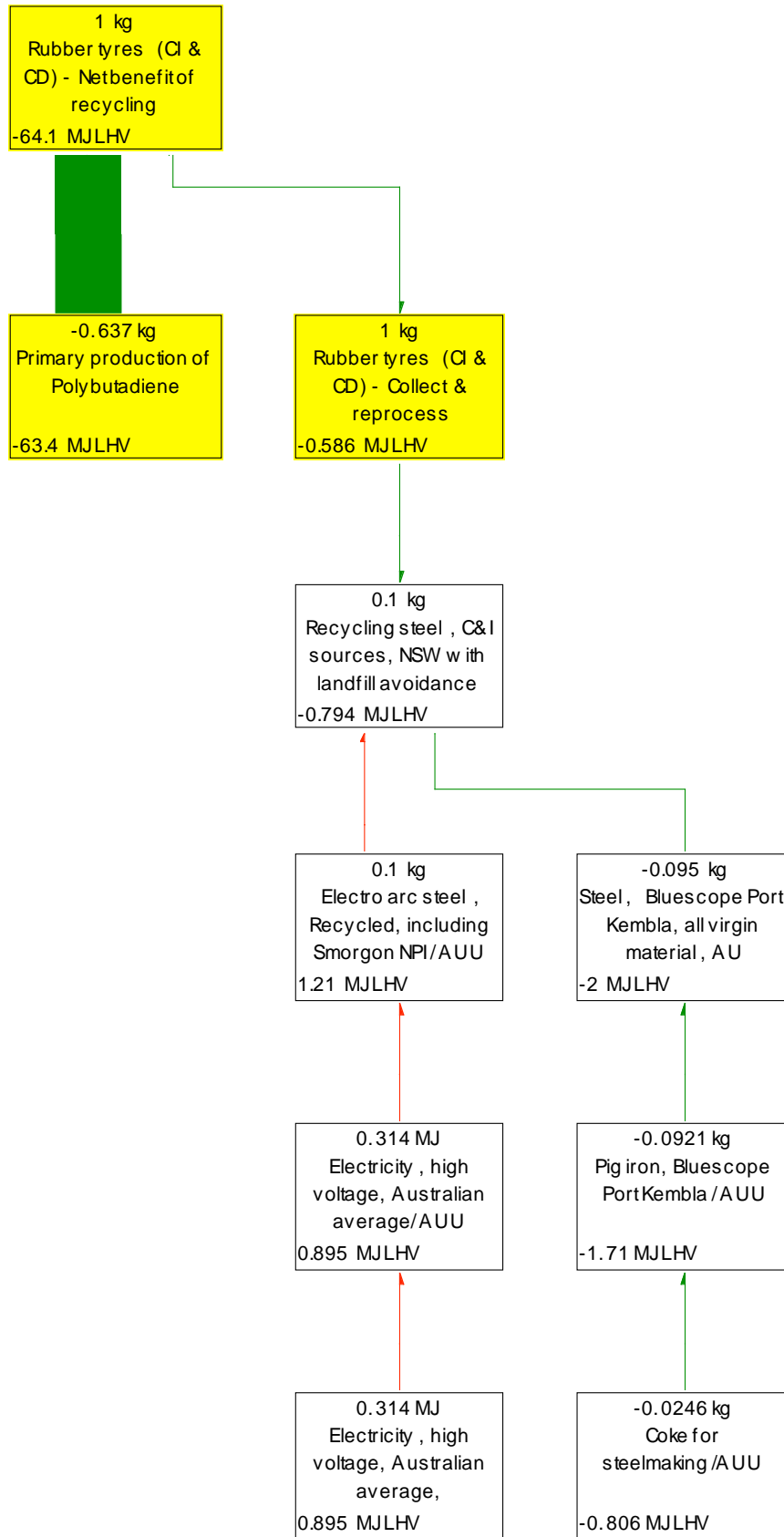
- Apelbaum Consulting Group (2001), Australian Transport facts 2001 Tables in Excel Format, Blackburn, Victoria.
- Atech Group (2001), A National Approach to Waste Tyres, Atech Group, prepared for Environment Australia, publicised by the Commonwealth Department of Environment
- BHP Minerals (2000), LCA of steel and Electricity Production — ACARP Project C8049 — Case Studies B Summary of Inventory Values for Electricity Production, Newcastle
- Delft University of Technology (1996), data from the Section for Environmental Product Development, Faculty of Industrial Design Engineering, The Netherlands
- Grant and James (2005), Life Cycle Impact Data for resource recovery from C&I and C&D waste in Victoria final report, Melbourne, Victoria, Centre for Design at RMIT university ([www.cfd.rmit.edu.au](http://www.cfd.rmit.edu.au))
- IVAM 4.0 Database (2004), IVAM Environmental Research, Amsterdam, Netherlands, from [www.ivam.nl/index.php?id=164&L=1](http://www.ivam.nl/index.php?id=164&L=1)
- Strezov, L., Herbertson, J. (2006), A life cycle perspective on steel building materials. Sydney, Australian Steel Institute
- Swiss Centre for Life Cycle Inventories. (2004). "EcoInvent Database version 1.01." from <http://www.ecoinvent.ch/en/index.htm>.
- Tellus Institute (1992), Tellus Packaging Study, for the Council of State Governments, US EPA and New Jersey Department of Environmental Protection and Energy

## Network diagrams — C&I and C&D collection

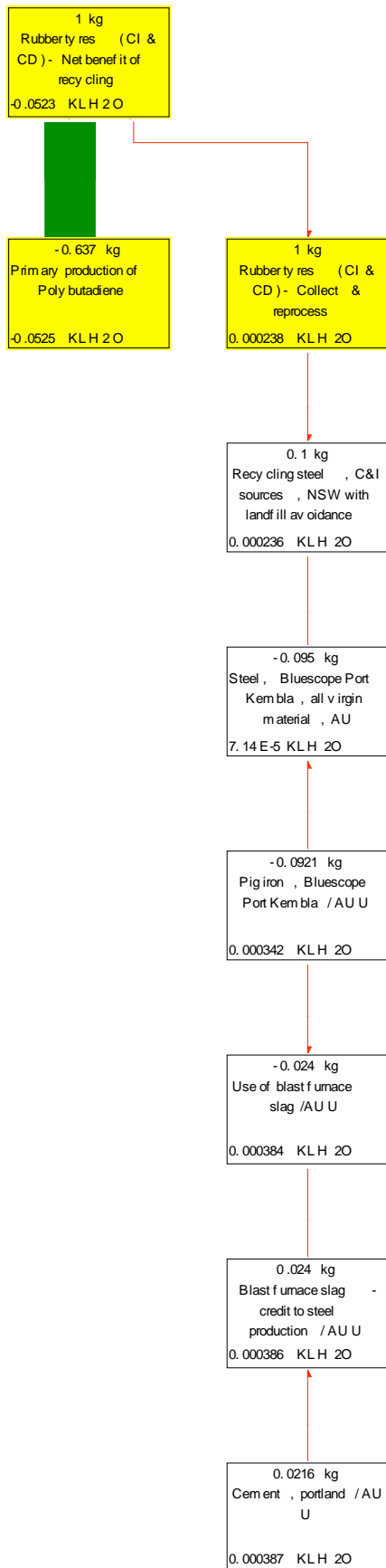
**Figure 39: Recycling process network diagram — Green house gases indicator. Processes contributing less than 2 per cent to total are not shown. Major processes from results table above are shown shaded.**



**Figure 40: Recycling process network diagram — Cumulative energy demand indicator. Processes contributing less than 1 per cent to total are not shown. Major processes from results table above are shown shaded.**



**Figure 41: Recycling process network diagram — Water indicator. Processes contributing less than 0.5 per cent to total are not shown. Major processes from results table above are shown shaded.**



**Figure 42: Recycling process network diagram — Solid waste indicator. Processes contributing less than 1 per cent to total are not shown. Major processes from results table above are shown shaded.**

